



SEMPRE

CREATING VALUE

Contents

INDUSTRIES	
Automotive.....	1
Aerospace.....	2
Medical Devices.....	3
Precision Engineering.....	4
Packaging.....	5
Electronics.....	5
INDUSTRIAL METROLOGY	
Optical Shaft Measurement.....	7
Multi-Sensing CMMs.....	8
Articulated Measurement Arms.....	9
3D Optical Profiling.....	10
2D Field Of View Measurement.....	11
3D White Light Scanning & Reverse Engineering.....	12
Roundness And Form.....	13
Roughness And Contour.....	14
CMM Systems.....	15
Verification Artifacts.....	16
Tube And Bore Inspection.....	17
Instant 2D Profile Measurement.....	18
Custom Solutions.....	19
Process Automation.....	20
Quality Management Software.....	21
Industrial Data Acquisition Software.....	22
Machine Tool Data Collection Software.....	23
MEASURING INSTRUMENTS	
Hand Tools.....	25
Height Gauges.....	26
Tachometers, Stroboscopes & Data Loggers.....	27
Force And Torque.....	28
Portable Roughness And Contour Testers.....	29
Thread Depth And Plug Gauges.....	30
Linear Digital Measuring Systems.....	31
ENGINEERING SERVICES	
Service, Calibration, Repairs & Upgrades.....	33
Training.....	34
Design And Development Services.....	35
Contract Measurement Services.....	36
Support Agreements.....	37
LEAN ENTERPRISE	
Computer Protection.....	39
Quality Points.....	40
Lean Approaches.....	41
Visual Communication.....	42
Workflow Solutions.....	43
Anti-Fatigue Matting, Floor Markings And Signage.....	44
Training Solutions.....	45
Symposium.....	46
Hire Our Space.....	47
OUR EMPLOYEES	
OUR PARTNERS	

The Sempre Group

Creating value for our employees,
our partners and our customers.

Values

INTEGRITY AND TRUST

PASSION TO OUTPERFORM

POSITIVITY AND ENJOYMENT

LISTEN, CARE AND RESPECT

EXCELLENT CUSTOMER SERVICE

GROW TOGETHER AS PARTNERS

**ACCURACY, EXPERTISE
AND RELIABILITY**

Independently providing
trusted products,
services and solutions.



**INDUSTRIAL
METROLOGY**



**MEASURING
INSTRUMENTS**



**ENGINEERING
SERVICES**

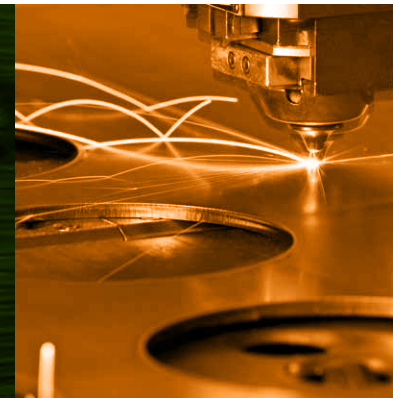

**INDUSTRIAL
SOFTWARE**



**LEAN
ENTERPRISE**

TheSempreGroup.com

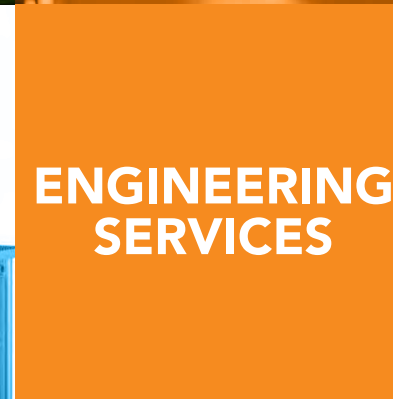

ENGINEERING SERVICES

- ▼ SERVICE, CALIBRATION, REPAIRS & UPGRADES
- ▼ TRAINING
- ▼ DESIGN AND DEVELOPMENT SERVICES
- ▼ CONTRACT MEASUREMENT SERVICES
- ▼ SUPPORT AGREEMENTS

5.0
RATING



“The communication from The Sempre Group was first class, I called regarding an issue with our machine, Hollie Flaherty was more than helpful in resolving the situation. Eric Newell was professional and knowledgeable throughout. We were taken aback by the willingness of Eric to assist, considering he was called here at the last minute it didn't seem a problem with him, he was in no hurry to get away, a very professional engineer. At this moment in time, there isn't much room for improvement. 5 stars.”

Ian Goodwin

Chief Inspector | MTS Precision | Bifold Group

SERVICE, CALIBRATION, REPAIRS & UPGRADES

Our team of skilled engineers are available for on-site service and calibration, to ensure the integrity and quality of your systems

- › Calibration and servicing schedules to suit your business
- › Rapid response to your service needs
- › In house repairs laboratory
- › Assurance our team is always available and have the knowledge to help

Upgrades to Windows 10 available for Opticline, Micro-Vu and Form Testers

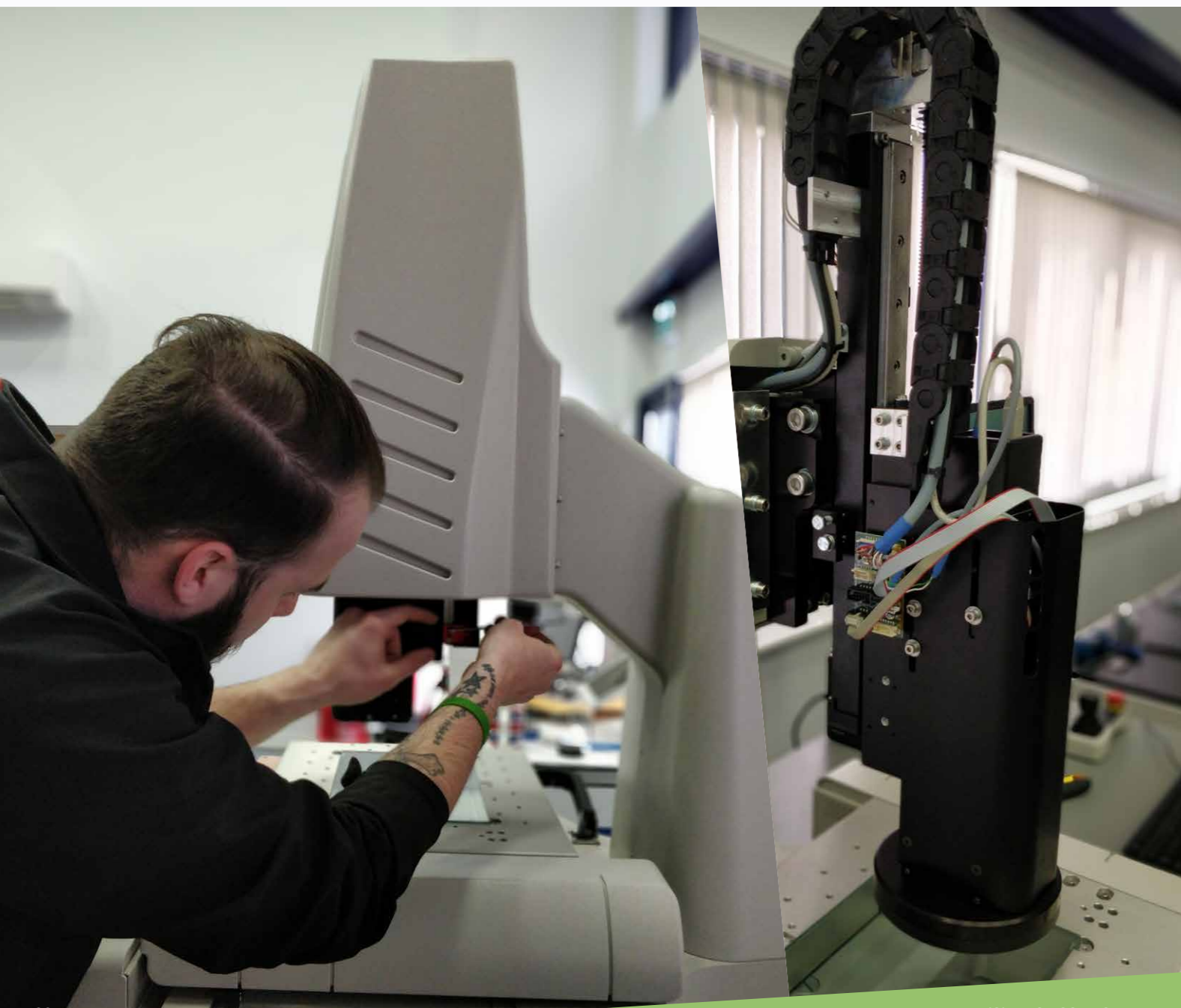

TRAINING

GET THE MOST FROM YOUR MEASURING SYSTEM. YOU'VE MADE THE INVESTMENT, NOW MAKE IT WORK FOR YOU.

Invest in your team:

- › Hands-on, practical training
- › Tailored to your industry and your products

We can offer training at your facilities or on-site at The Sempre Group.

- › Utilise your new and old machines
- › Create measuring routines
- › Keep operators up-to-date with new techniques and capabilities
- › Ability to troubleshoot measurement issues
- › Improve production efficiency
- › Encourage focus on the integrity and quality of your products
- › Health and safety compliance

System options:

- | | |
|-------------|--|
| › Micro-Vu | › HighQA software |
| › Innovalia | › Prolink SPC software |
| › Opticline | Basic or advanced training, held over two or three days. |
| › Planar | Need something bespoke? Let us know! |
| › Optiscan | |
| › Accuity | |
| › Roundscan | |

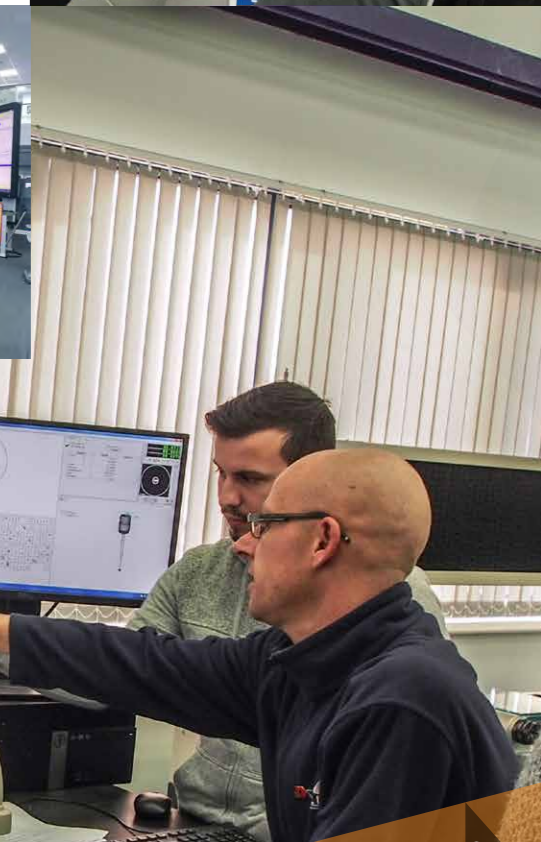

DESIGN AND DEVELOPMENT SERVICES

CONTRACT MEASUREMENT SERVICES

CONTRACT DESIGN AND PROGRAMMING

Support with:

- › Designing Jigs, Fixturing and Enclosures
- › Programming your systems

Delivering Customised Software Solutions:

- › Bespoke automation
- › Data analysis
- › Neural networks
- › Vision recognition

Let our team of skilled engineers do the hard work.

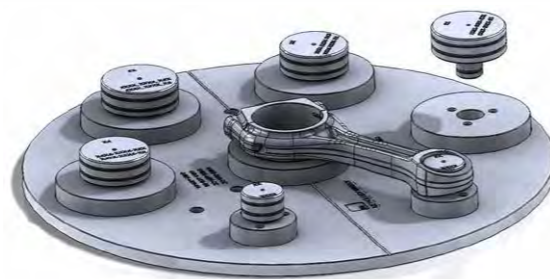
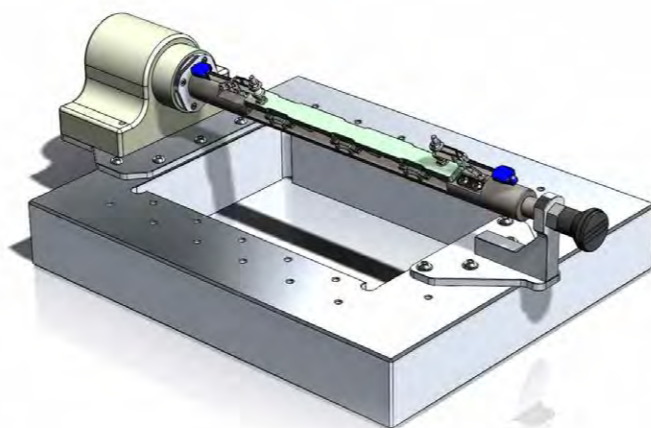
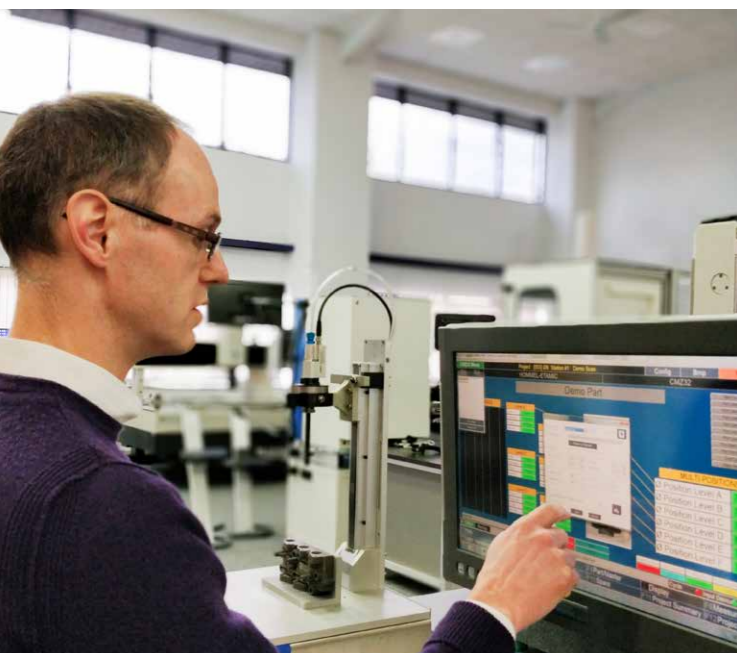

OUR SCOPE

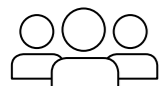

In House Capability:

- › Full 3D CAD/CAE model and drawings using Solidworks
- › Consultation – quality management and shopfloor layout



Experience:

- › Over 120 years of combined experience in aerospace design, mechanical engineering, automotive engineering and quality

WE WILL DO MEASUREMENT AND INSPECTION REPORTS FOR YOU

CONTRACT MEASUREMENT

Meeting Your Measurement Requirements:

- › On time and on budget
- › Accurately
- › Detailed report provided

Options include:

- › Initial sample inspection reports
- › Single and batch inspection
- › Reverse engineering
- › Offline part programming service
- › Statistical reports (gauge R&R/ CP/ CPK)
- › Gauge, fixture design and verification
- › 2D and 3D scanning

OUR SCOPE

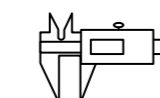

Equipment:

- › Optical and Contact CMMs
- › Optical Shaft Measurement
- › Contour and Surface Finish
- › Form and Roundness
- › Auto Ballooned Inspection Reports
- › Fully Detailed Reporting and Analysis

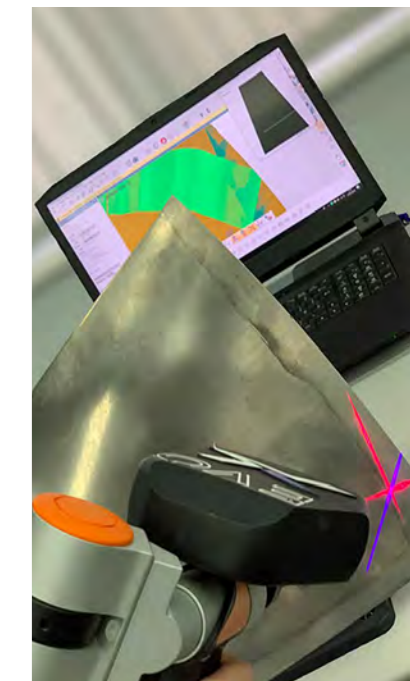
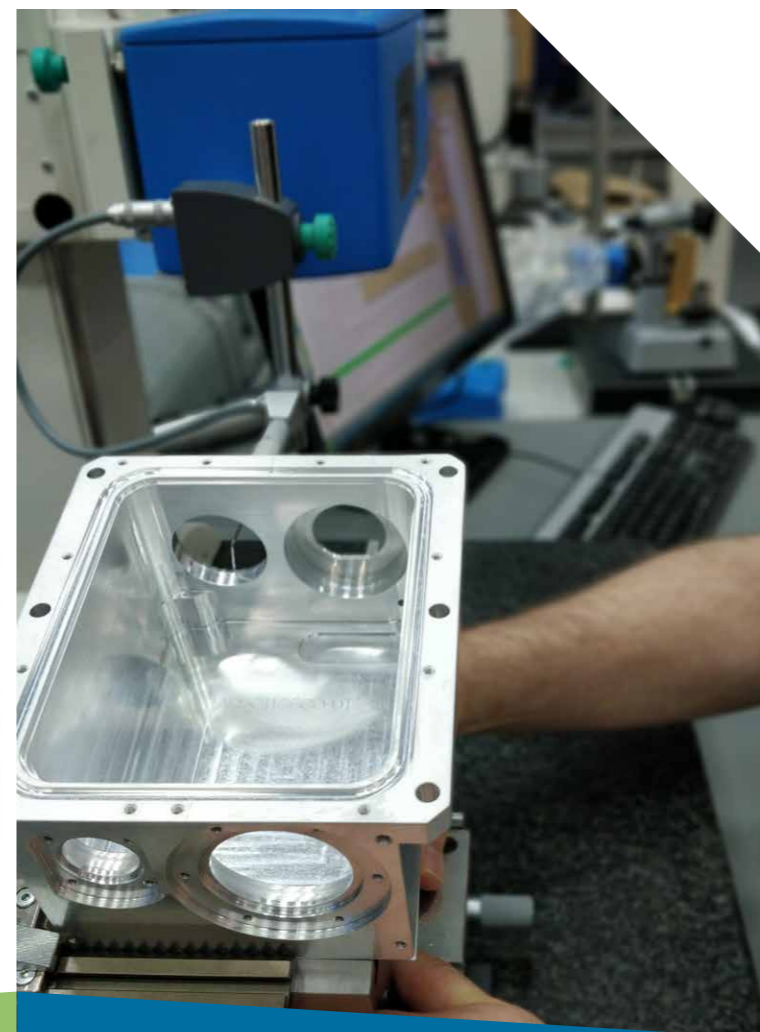

SUPPORT AGREEMENTS

A service and maintenance agreement between you and The Sempre Group. We can provide different levels of support, according to your needs, to help provide peace of mind.

- › Telephone support
- › Remote support (internet access required)
- › Priority response (within 24 hours)
- › Breakdown cover
- › Annual / 6 monthly / 3 monthly calibrations (including traceable calibration certificates)
- › HDD imaging

BENEFITS:

- › Fixed costs
- › Priority response assurance and 24hr response time
- › Security and protection
- › Improve: Efficiency, performance, protection
- › Reduce: Breakdowns, expenses, downtime

OPTIONS

PLATINUM

- › Annual service and calibration (including traceable calibration certificates)
- › Telephone support
- › Remote support (internet access required)
- › HDD imaging
- › On-site breakdown visits
- › 24hr response time
- › Priority booking
- › Breakdown and parts cover

GOLD

- › Annual service and calibration (including traceable calibration certificates)
- › Telephone support
- › Remote support (internet access required)
- › HDD imaging
- › On-site breakdown visits
- › 24hr response time
- › Priority booking

SILVER

- › Annual service and calibration (including traceable calibration certificates)
- › Telephone support
- › Remote support (internet access required)
- › HDD imaging



LEAN ENTERPRISE

- › COMPUTER PROTECTION
- › QUALITY POINTS
- › LEAN APPROACHES
- › VISUAL COMMUNICATION
- › WORKFLOW SOLUTIONS
- › ANTI-FATIGUE MATTING, FLOOR MARKINGS & SIGNAGE
- › TRAINING SOLUTIONS
- › SYMPOSIUM & HIRE OUR SPACE



“I would like to share my gratitude to your company. Thank you so much for the speedy service and delivery, ensuring our order arrived in time to be installed before our customer visit; I am extremely grateful. As we develop the site we will be ordering more. Thanks very much.”

Rebecca Hammond
Training and Development Leader, NALCO | An Ecolab Company

COMPUTER PROTECTION

DESIGNED TO WITHSTAND INDUSTRIAL ENVIRONMENTS

COMPACT CABINETS TO STOP PCS BECOMING DAMAGED OR TAMPERED WITH ON THE SHOP FLOOR. SUITABLE FOR ALL ENVIRONMENTS

- › Robust stations designed to withstand harsh work environments
- › Lockable cupboards provide controlled access to hardware

Accessories:

- › Wheels with brakes
- › Magnetic whiteboard for display of information or procedures
- › Perspex doors to ensure 5S process can be monitored and maintained easily



INSPECTION WORKSTATIONS

BENCHES DESIGNED TO ADAPT TO YOUR WORK PROCESS, WITH OPTIONAL ACCESSORIES FOR ENHANCED USABILITY

Accessories:

- › Wheels with brakes
- › Magnetic board for displaying information
- › Perspex doors to help manage 5S
- › Rail for bins
- › Cupboards
- › 5S Drawers
- › Magnetic accessories including display frames of all sizes



LEAN APPROACHES

VISUAL COMMUNICATION

IMPLEMENTING A LEAN PROJECT?

SYSTEMS SPECIFICALLY DESIGNED TO HELP IMPLEMENT LEAN PROCESSES SUCH AS 5S, TPM OR KANBAN.

Extensive Range of Products and Solutions:

- › Shadow boards
- › 5S workbenches
- › Bespoke roller-racking
- › FIFO systems
- › Mobile loading systems
- › Cleaning stations
- › Visual performance indicators



MAGNETIC WHITEBOARDS, ACCESSORIES AND SIGNAGE

Magnetic Whiteboards

- › Stand-alone
- › Wall-mounted
- › Space-saving designs
- › Communication areas

Magnetic Accessories

- › Display frames
- › Clipboards
- › Magnetic visual indicators

Signage

- › Safety procedures and visual reminders
- › Standardised colour schemes



WORKFLOW SOLUTIONS

ANTI-FATIGUE MATTING, FLOOR MARKINGS AND SIGNAGE

WORKSTATIONS, CONVEYOR BELTS AND RACKING SYSTEMS

CREATED ESPECIALLY TO SUIT YOUR REQUIREMENTS FOR SIZE, SPACE AND USAGE

- › Cabinets
- › Machine Guarding
- › Trolleys
- › Conveyors
- › Partitions
- › Work Benches
- › Machine Frames
- › Storage Systems



MATTING AND MARKINGS FOR INDUSTRIAL ENVIRONMENTS

REDUCE IMPACT OF STANDING WITH ANTI-FATIGUE MATTING. CLEARLY DEFINE WALKWAYS AND SPECIFIC AREAS WITH OUR INDUSTRIAL FLOOR ADHESIVE RANGE.

Durable Solutions:

- › Matting made to any size
- › Multiple colours
- › Options to cover and contain cables
- › Personalise with logos or messages
- › Durable floor tape for heavy industrial environments
- › Safety markings and signs
- › Sensor lit signs

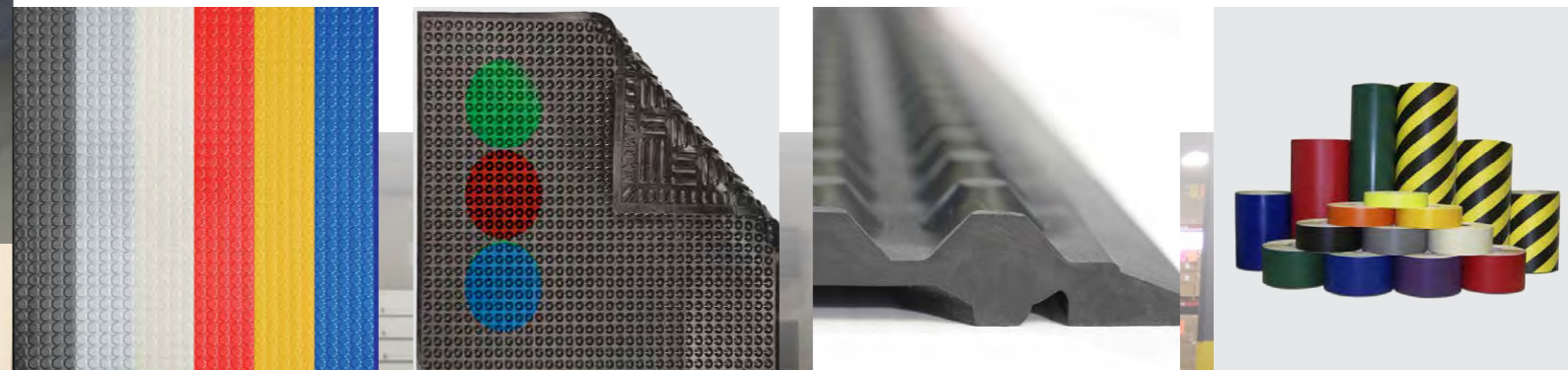

TRAINING SOLUTIONS

SYMPOSIUM

TRAINING GAMES AND KITS

SOLUTIONS FOR INTRODUCING THE IMPLEMENTATION AND BENEFITS OF LEAN PROJECTS TO STAFF

Training Games:

- › Have fun and encourage people to learn through experience
- › Make plans together as a team to implement your projects
- › Get the whole team on-board

Training Kits:

- › These kits are designed to help you start your lean strategies
- › Introducing processes on a small level to the team and then create a more standardised procedure

LEAN MANUFACTURING TECHNIQUES AND IMPLEMENTATION

SEE OUR SOLUTIONS IN ACTION

Attend our Symposium

Have a go at the games yourself to learn more about our lean solutions and how they could help you. To book your place please contact us.



HIRE OUR SPACE

UTILISE OUR LEAN PRODUCT RANGE TO TRAIN STAFF, OR USE THE OPEN SPACE FOR MEETINGS OR TRAINING. OPTIONAL CATERING AVAILABLE

Book Our Space

“The space & service levels offered by The Sempre Group needed for us to run our corporate Lean training programme are fantastic. There is enough room to run a factory simulation and deliver classroom style learning to our 26+ delegates. The staff are very helpful, professional and nothing is too much effort.”

The facilities are comprehensive and flexible allowing the use of several breakout rooms. The 3 times we have used the space our delegates have only had positive comments to make about the venue. Value for money is important when running a course on this scale, compared with other local venues The Sempre Group are competitive.”

Gavin Bellizzi | CI Manager | Darchem Engineering Ltd | Esterline Engineered Materials

CONTACT US

THE LODGE,
37 BARNETT WAY
BARNWOOD
GLOUCESTER
GL4 3RT

sales@thesempregroup.com
service@thesempregroup.com
accounts@thesempregroup.com
+44(0)1452 632712

Follow us on:   

Sign up for our Newsletter for updates on our latest offers and events.



TheSempregroup.com

