

ACTON[®]

FINISHING



we redefine
Surface Finishing



Table of Contents

About ActOn Finishing	pg. 4
A Global Service	pg. 6
Finishing Applications	pg. 8
Portable Series	pg. 10
Vibratory Finishing Bowls	pg. 14
Vibratory Finishing Troughs	pg. 16
Dryers	pg. 18
Duals	pg. 20
Wheel Polishing Machine	pg. 22
Centrifugal Disc Finishing Machine	pg. 24
Centrifugal High Energy Finishing Machine	pg. 26
Waste Water Treatment	pg. 28
Accessories	pg. 30
Automated Systems	pg. 32
DLyte Electropolishing	pg. 38
Shot Blasting Cabinets	pg. 44
Wheel Blasting Systems	pg. 60
Consumables	pg. 66
Subcontract Services	pg. 76
What Our Customer Say	pg. 78



About ActOn Finishing

ActOn Finishing is UK's leading expert in designing and developing the state-of-the-art machinery and mass finishing solutions of tomorrow.

Established in 1965 as a UK leading family business, we've worked hard to design, develop and manufacture a product of high British standard that will redefine your work. We cater to a range of industries including Aerospace, Additive Manufacturing, Automotive, Coin Blanking, Forgings and Castings, General Engineering, Hospitality and Medical. Our products and services include:



Mass Finishing Technology

We offer our own range of Mass Finishing technology, designed to be simple to operate and highly efficient, while it helps you to improve your current process and to achieve repeatable results.



Shot Blasting Technology

ActOn Finishing distributes a wide range of shot blasting machines including: Wet Blast Cabinets, Suction Blast Cabinets, Pressure Blast Cabinets, Portable Abrasive Blasting Cabinets and a Wheel Blasting Series.

Our Customers



Waste Water Treatment

During the finishing operation, the effluent can be polluted with oil, media and metal fines. Our customers trust us to help select a waste water treatment system that complies with the industry's growing regulations. Once processed, the effluent is treated in the ActOn centrifuge system before being discharged to the drain or recycled.



Finishing Media

Our consumables are an important aspect of finishing. From ceramic, plastic and drying media to shot blasting media, we ensure that you achieve the optimum results in the most cost-effective way.



DLyte Technology

DLyte Finishing Technology is a fully automatic finishing system which enables you to deburr, grind, surface finish & mirror polish in one step. It is used for metal parts which require high performance or superior finishes, including steel and stainless-steel, cobalt chrome, titanium, nickel and other common metal alloys.



Liquid Compounds

Compounds are very important to the mass finishing process. At ActOn we manufacture an extensive range of specially formulated compounds, which suit almost any application. Our compounds reduce media costs & process time and are biodegradable, too.



Automation

Both the Vibrota and High Energy can be automated to reduce manual handling, and to ensure a consistent process. Our automated systems are operator friendly, and can be custom built to suit your needs.



Subcontract Facility

Our subcontract facility is equipped with state-of-the-art Vibratory & High Energy finishing machines and Shot Blasting Cabinets. We can provide a speedy finishing solution, as well as a high quality finish on parts & we can process parts of variable sizes and batch quantities.

A Global Service

As a process driven business, we provide to our customers around the world, the most optimum cost-effective solutions to achieve their required standards in highly demanding markets. Our aim is to achieve customer satisfaction through continuous improvement in our approach and practices. We like to call it our Global Service.

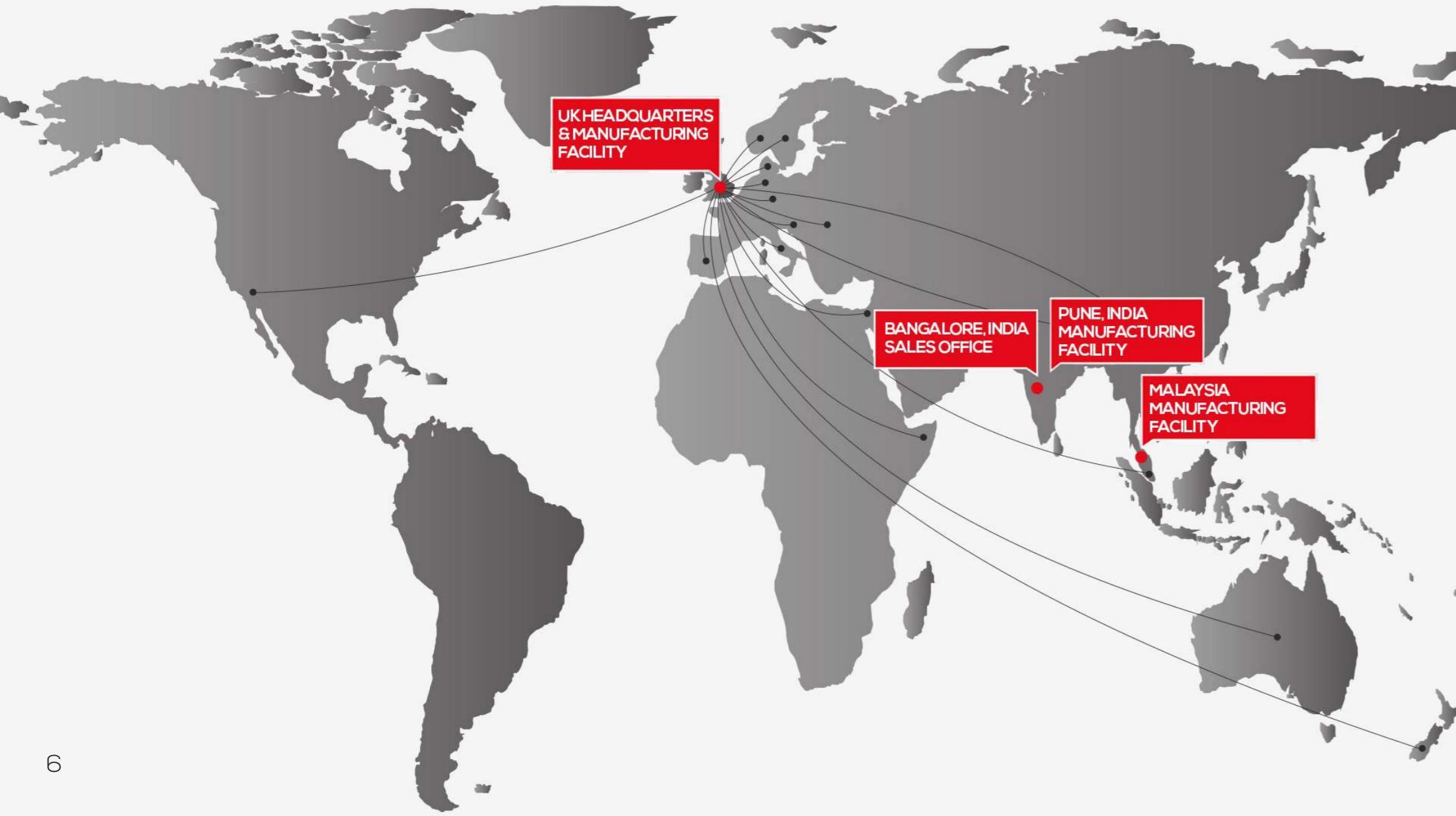

Our Values



Adaptability

We respond to change with a positive attitude and a willingness to learn new ways to accomplish objectives.



Customer Focused

We listen to our internal and external customers and are focused on building sustainable relationships.



Teamwork

We work as a team to deliver the best outcome for each other on the foundation of trust and integrity.



Openness

Our sense of directness, candour and diversity encourages people and ideas to thrive.



Nimble

We are efficient in what we do and take an initiative to improve our processes without compromising on quality and service.

Our Mission

As a process driven business, we provide our customers the most optimum cost-effective solutions to achieve their required standards in highly demanding markets. Our aim is to achieve customer satisfaction through continuous improvement in our approach and practices.

Our Vision

To be recognized in the UK and international markets as a leading manufacturer and provider of surface finishing solutions, including equipment, consumables and subcontract services.

Finishing Applications

Deburring

Descaling & Cleaning

Degreasing & Oil Removal

Smoothing

Radiusing

Brightening & Polishing

Surface Finishing

Drying

Corrosion Protection

Shot Blasting & Peening

Turbocut

For rapid removal of surface defects on ferrous parts.

Chemcut

For the quick improvement of the surface finish (Ra values) on ferrous parts.

ActoGrind

For heavy removal of grinding lines using mass finishing methods.



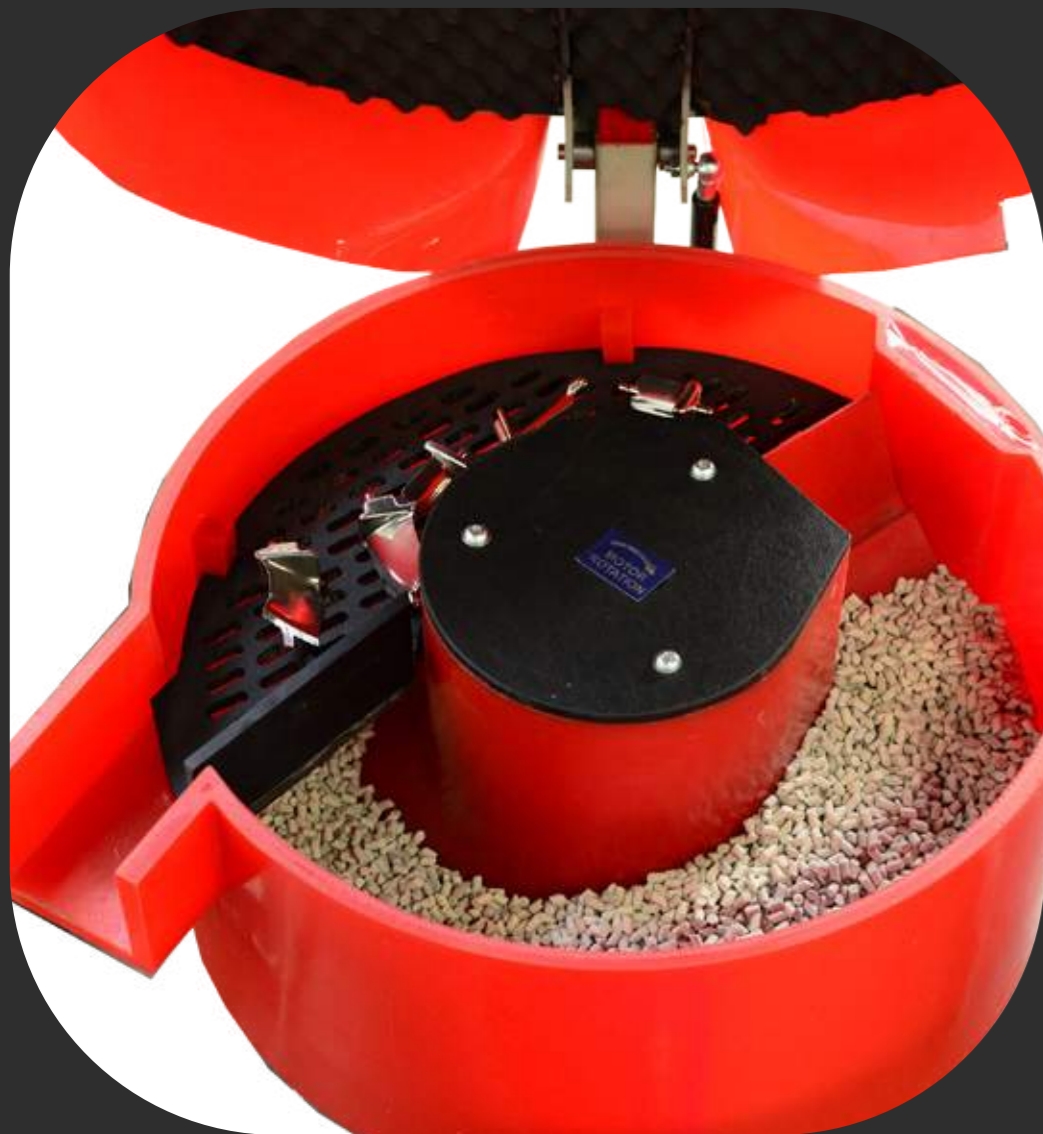

Portable Series

ActOn Portable Finishing Machines has been designed to allow manufacturers of small components or low volumes to achieve superior finishes at a lower investment. This series is perfect for a wide range of applications, from deburring, descaling, smooth finishing and grinding to polishing, burnishing and surface finishing.

Click [here](#) to download our Vibratory Finishing brochure for further technical information.



Bench Mounted Series

These machines are ideally suited for small batch works and are capable of deburring, burnishing, radiusing, descaling, polishing, cleaning and surface improvement. The bowl is cast as a single moulding and is extremely robust in its construction. The machine operates via a standard DOL starter and is easy to operate. Both O series and S series type machines are in our range of manufacture.

HT Series

The HT vibratory trough machine houses a work chamber which is polyurethane lined and works on the same principle as the TU series trough machines. The machines are mounted on castor wheels and can be moved with ease. The unit also has its own recirculating tank with pump for dosing the mixture of water and compound for the process. Generally quiet in operation, the machines run on a standard 16A socket, 1 phase, 240V AC supply thus making it a very user friendly kit for deburring or burnishing operation.

HT2D Series

HT2D dryer is perfect for drying small and medium sized parts. This space-saving machine can be used as either a batch or a continuous drying machine. The HT2D machine is also recommended for polishing using agro and pre-treated media. Parts are manually inserted into the dryer's preheated polyurethane lined work chamber and then dried using agro media. The dust free agro product, used in the HT2D, is an excellent moisture absorbent media which also produces a stain free polish effect on components.



VB1S



HT2



HT2D

Technical Specifications

Model	Capacity		Overall dimensions in mm/ inch			Chamber dimension in mm/ inch after lining			Max Motor Rating (kW)
	Cu. Ft.	Litres	Length	Width	Height	Length	Width	Height	
VB1	1	28	730 / 28.7	630 / 24.8	600 / 23.6		150 / 5.9	230 / 9.1	0.18
VB1S	1	28	730 / 28.7	700 / 27.5	600 / 23.6		150 / 5.9	230 / 9.1	0.18
HT2	2	60	825 / 32.5	725 / 28.5	971 / 38.2	575 / 22.6	395 / 15.5	368 / 14.5	0.34 kW - 1500 rpm 0.50 kW - 3000 rpm
HT2D	2	60	825 / 32.5	725 / 28.5	971 / 38.2	575 / 22.6	395 / 15.5	368 / 14.5	0.34 kW - 1500 rpm 0.50 kW - 3000 rpm

SPU-1 Vibratory Finishing System

This Single Portable Unit is ideally suited for small batch works and delicate components and can be used as either a batch or a continuous system. This vibratory finishing system is perfect for deburring, descaling, degreasing, cleaning, smoothing, radiusing, polishing and drying. This is both an excellent and economical finishing option.

Simply insert the parts in the VBIS machine and then process these with a specially formulated media and compound. Once the wet finishing process is completed, the parts are then transferred into the VBDIS machine in the preheated work chamber to be dried. The dust free agro product, used in the VBDIS, is an excellent moisture absorbent media which also produces a stain free polished effect on parts. Components are then unloaded from the machine via the separation screen.

System Benefits and Features

- Portable unit.
- Perfect for wet and dry applications.
- Built in compound recirculation system.
- Water/compound can be filled from the side of the machine.
- Available in 3 phase and 1 phase.
- Compact design
- British built high-quality product
- Efficient and quiet in operation
- Operator friendly controls

>> Click [here](#) to request a Free Trial!



Control System

VBD1 Dryer

Components are loaded in the dryer via a side loading chute. Design includes heating elements provided to heat the drying media (maizaorb) which acts as an absorbent and removes any moisture from the parts.

Parts Collection Tray

Storage Area

VBIS Vibratory Bowl

Designed with automatic separation system to separate parts from media at the end of finishing process. Components are then discharged to the next sequence of the process to be dried.

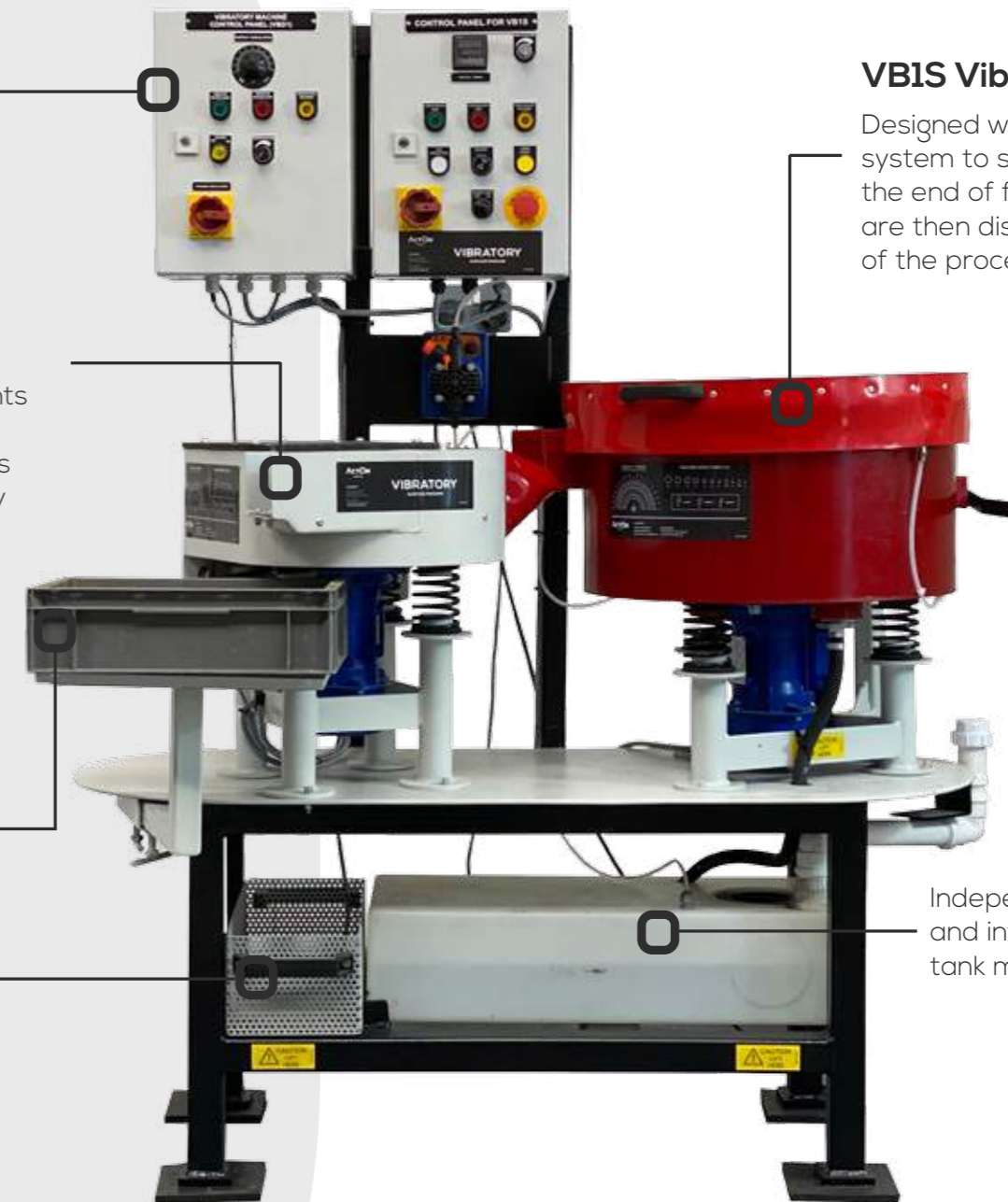

Independent recirculation system and integrated water filtration. The tank maximum capacity is 30L.

Vibratory Finishing Bowls

Built to suit various customer applications from deburring, descaling, radiusing and cleaning to polishing and surface improvement.

Key Features

- Wear-resistant casted hot cured polyurethane lining.
- Acoustic lid for noise reduction.
- Undersized media separation / Inverse separation.
- Single and variable speed motor.
- Powerful drive system with sealed bearings for maintenance-free running.
- Flyweights set for optimum action in bowl.

Click [here](#) to download our Vibratory Finishing brochure for further technical information.



Key Benefits

- Both large and small batches of parts can be finished.
- Operator friendly controls.
- Low maintenance.
- Manual / Auto functionality.
- British built high-quality product.
- Reduced processing times in comparison with manual finishing.
- Efficient and quiet in operation.

Technical Specifications

Model	Capacity		Overall dimensions in mm/ inch			Chamber dimension in mm/ inch after lining		Max Motor Rating (kW)
	Cu. Ft.	Litres	Length	Width	Height	Width	Height	
VB3	3	85	1130 / 44.5	865 / 34	1080 / 42.5	250 / 9.8	290 / 11.4	1.2
VB5	5	142	1455 / 57.2	1150 / 45.2	1175 / 46.3	230 / 9.1	350 / 13.8	2.2
VB10	10	283.5	1690 / 66.5	1390 / 54.7	1170 / 46.1	330 / 13	465 / 18.3	4
VB20	20	567	2070 / 81.5	1750 / 68.9	1270 / 50	365 / 14.4	515 / 20.3	7
VB30	30	850	2300 / 90.6	1970 / 77.6	1425 / 56.1	400 / 15.7	565 / 22.2	7.5
VB3S	3	85	1130 / 44.5	900 / 35.4	1080 / 42.5	250 / 9.8	290 / 11.4	1.2
VB5S	5	142	1455 / 57.3	1150 / 45.3	1175 / 46.3	230 / 9.1	350 / 13.8	2.2
VB10S	10	283.5	1690 / 66.5	1475 / 58.1	1235 / 48.6	330 / 13	515 / 20.3	4
VB20S	20	567	2070 / 81.5	1750 / 68.9	1270 / 50	365 / 14.4	515 / 20.3	7
VB30S	30	850	2300 / 90.5	1970 / 77.5	1425 / 56.1	400 / 15.7	565 / 22.2	7.5

Vibratory Bowls Series



O Series (Standard)
Both large and small batches of parts can be processed in this machine, where manual separation is mandatory.

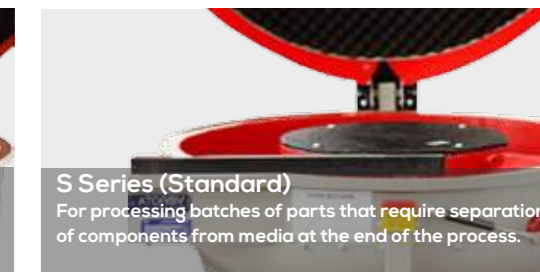

S Series (Standard)
For processing batches of parts that require separation of components from media at the end of the process.

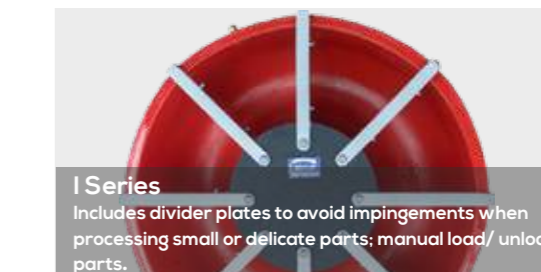

I Series
Includes divider plates to avoid impingements when processing small or delicate parts; manual load/unload of parts.

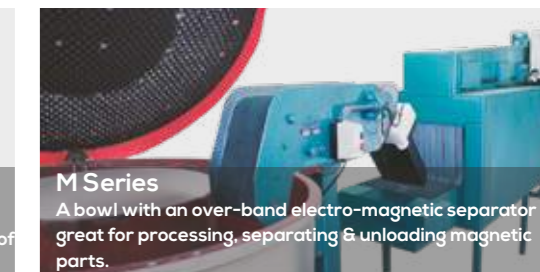

M Series
A bowl with an over-band electro-magnetic separator great for processing, separating & unloading magnetic parts.

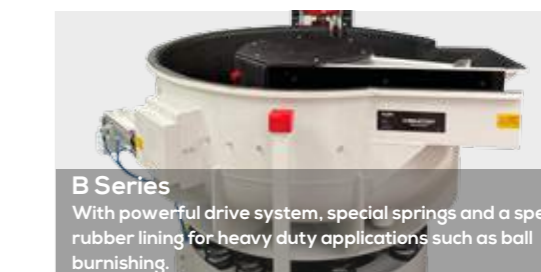

B Series
With powerful drive system, special springs and a special rubber lining for heavy duty applications such as ball burnishing.

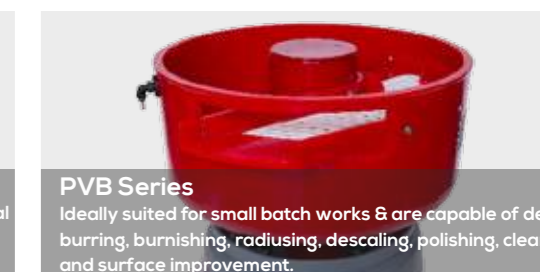

PVB Series
Ideally suited for small batch works & are capable of deburring, burnishing, radiusing, descaling, polishing, cleaning and surface improvement.

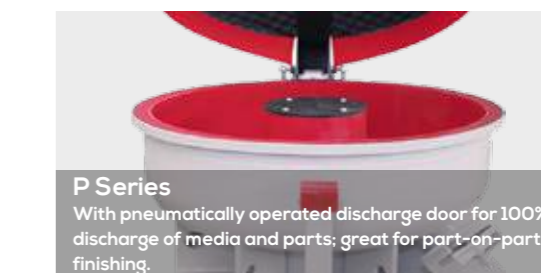

P Series
With pneumatically operated discharge door for 100% discharge of media and parts; great for part-on-part finishing.

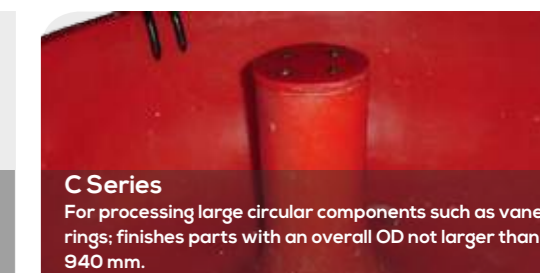

C Series
For processing large circular components such as vane rings; finishes parts with an overall OD not larger than 940 mm.

Vibratory Finishing Troughs

Offered in various standard sizes and a choice of combinations of lengths and widths, the troughs are perfect for finishing larger, longer and irregular-shaped components.

Key Benefits

- Suits various customer applications from deburring, descaling, radiusing and cleaning to polishing and surface improvement.
- Both large and small batches of components can be processed in this machine.
- Operator friendly controls
- Low maintenance
- Manual / Auto functionality
- British built high-quality product
- Reduced processing times in comparison with manual finishing

Key Features

- Designed and manufactured with a single speed motor as a standard feature with adjustable flyweights set to transfer the optimum amount of energy to produce a finish in the most efficient manner.
- Wear-resistant casted hot cured polyurethane lining
- Acoustic lid for noise reduction
- Easy to access working chamber.
- Work chamber can be sub-divided using divider plates to provide separate compartments for precision or delicate parts.
- Separation of parts and media is done manually.
- Design ensures ease of customisation.



TU3 System with Dosing Unit, Settlement Tank and Control Panel

Technical Specifications

Series	Model	Capacity		Overall dimensions in mm/ inch			Trough dimension in mm/ inch after lining			Max Motor Rating (kW)
		Cu. Ft.	Litres	Length	Width	Height	Length	Width	Height	
TU series	TU3	3	85	1000 / 39.4	850 / 33.5	1085 / 42.7	575 / 22.6	370 / 14.5	445 / 17.5	0.95
	TU4	4	113	1225 / 48.2	850 / 33.5	1085 / 42.7	800 / 31.5	370 / 14.5	445 / 17.5	1.2
	TU7	7	198	1725 / 67.9	850 / 33.5	1085 / 42.7	1300 / 51.2	370 / 14.5	445 / 17.5	1.7
	TU8	8	227	1415 / 55.7	1000 / 39.4	1280 / 50.4	930 / 36.6	450 / 17.7	560 / 22	2.2
	TU9	9	255	2075 / 81.7	850 / 33.5	1250 / 49.2	1650 / 64.9	370 / 14.5	445 / 17.5	2.2
	TU10	10	283	1670 / 65.7	1000 / 39.4	1280 / 50.4	1185 / 46.6	450 / 17.7	560 / 22	2.2
	TU12	12	340	1325 / 52.1	1255 / 48.2	1485 / 58.5	895 / 35.2	645 / 25.4	710 / 27.9	2.2
	TU14	14	397	2135 / 84.1	1000 / 39.4	1280 / 50.4	1650 / 64.9	450 / 17.7	560 / 22	2.8
	TU18	18	510	1435 / 56.5	1400 / 55.1	1500 / 59.1	960 / 37.8	770 / 30.3	655 / 25.8	6
	TU20	20	567	1970 / 77.5	1255 / 48.2	1485 / 58.5	1540 / 60.6	650 / 25.6	710 / 27.9	6
	TU23	23	652	2175 / 85.6	1255 / 48.2	1535 / 60.4	1745 / 68.7	645 / 25.4	710 / 27.9	6
	TU23XW	23.5	666	2000 / 78.7	1400 / 55.1	1500 / 59.1	1520 / 59.8	770 / 30.3	655 / 25.8	6
	TU25	25	708	1380 / 54.3	1850 / 72.8	1980 / 77.9	940 / 37	1240 / 48.8	1070 / 42.1	7
	TU29	29	822	2680 / 105.5	1280 / 50.4	1570 / 61.8	2210 / 87	645 / 25.4	710 / 27.9	7
TU30	30	850	2000 / 78.7	1400 / 55.1	1650 / 64.9	1520 / 59.8	770 / 30.3	810 / 31.8	7	
TU50	50	1417	3600 / 141.7	1350 / 53.1	1800 / 70.8	3000 / 118.1	770 / 30.3	700 / 27.6	11	



TU4 Stainless Steel Option



TU7 with Divider Plates



Click [here](#) to download our Vibratory Finishing brochure for further technical information.



Dryers

Our dryers can be easily integrated with the ActOn vibratory finishing machines, thus offering a complete finishing solution for your components. ActOn dryers are also known for their 100% separation of parts and can be used as a batch process or single lap continuous process.

Key Features

- Metal spun process chamber (VBD Series)
- Easily customisable to suit customer requirements
- Durable reinforced screens can be used for heavier parts
- Dryers with compact design available, when there is a space restriction or you need to dry small and medium sized parts.

Technical Specifications

Series	Model	Capacity	Overall dimensions in mm/ inch			Chamber dimension in mm/ inch after lining		Max Motor Rating (kW)	Number of Heaters	Total Heater Rating (kW)
		Cu. Ft.	Length	Width	Height	Width	Height			
VBD Series	VBD1	1	600 / 23.6	500 / 19.7	500 / 19.7	98 / 3.8	150 / 5.9	0.18	1 off	0.5
	VBD3	3	1200 / 47.2	950 / 37.4	980 / 38.6	280 / 11	300 / 11.8	1.2	2 off	2
	VBD6	6	1650 / 64.9	1315 / 51.7	1000 / 39.4	260 / 10.2	335 / 13.2	2.2	3 off	3
	VBD12	12	2000 / 78.7	1620 / 63.7	980 / 38.5	365 / 14.4	370 / 14.6	4	3 off	3
	VBD24	24	2615 / 102.9	1930 / 75.9	1150 / 45.3	392 / 15.4	425 / 16.7	7	6 off	6



VBD Series

Dryer Series



VBD Series

Includes an elliptical shaped work chamber, which gives an extra drying area. Both large and small batches of parts can be dried, using heated drying media.



TU10D Series

First trough dryer on the market designed for drying large, long or irregular shaped parts which cannot fit into traditional bowl shaped dryers.



CFV Series

Best suited for drying large volumes of small components where the agro media cannot be used due to the risk of lodgement.



VBD-P Series

Designed for a drying application where 100% discharge of agro media and parts is required at the end of the finishing process.



CD Series

Best suited for drying a variety of parts, which are large in nature or where the agro media cannot be used due to the risk of lodgement.



RD Series

Includes an inner rotating chamber where the parts get dried using appropriate agro media which absorbs the moisture from the components.

Key Benefits

- British built high-quality product
- Efficient in operation
- Quiet in operation
- Process results in dry and clean parts
- Operator friendly controls
- Low maintenance
- Manual / Auto functionality

Click [here](#) to request a Free Trial!

Duals

The design of this space saving machine, integrates two process chambers:

- An inner chamber, with a hot cured polyurethane lining, that can be used for wet process applications such as deburring, descaling, radiusing, cleaning, polishing & surface improvement.
- An outer chamber for drying/cleaning the parts after being processed in the inner chamber.

The Dual finishing machine typically includes a separation system for each chamber to separate media from parts. At the end of finishing process in the inner chamber media is screened through the separation screen and is retained in the bowl, while the parts are discharged to the outer chamber for drying. This operation is repeated once the parts have been processed in the outer chamber and then suitably collected.



Key Features

- Wear-resistant casted hot cured polyurethane lining
- Design ensures ease of customisation
- Easy to access working chamber
- Removal of screens with our wedge type locking system reduces down time
- Option to include a time controlled powder feeder with an electrically controlled valve that dispenses powders into the machine.

Click [here](#) to download our Vibratory Finishing brochure for further technical information.

Technical Specifications

Series	Model	Bowl Capacity		Overall dimensions in mm/ inch			Process Chamber Dimensions in mm/ inch after lining		Dryer Chamber Dimensions in mm/ inch		Max Motor Rating (kW)	Number of Heaters	Total Heater Rating (kW)
		Cu. Ft.	Litres	Length	Width	Height	Width	Height	Width	Height			
Dual Machine	Dual 3+3	3+3	85+85	1430 / 56.3	1240 / 48.8	1100 / 43.3	250 / 9.8	290 / 11.4	155 / 6.1	240 / 9.4	2.2	2 off	1.5 x2
	Dual 5+5	5+5	142+142	1830 / 72	1500 / 59.1	1080 / 42.5	230 / 9.1	335 / 13.2	180 / 7.1	205 / 8.1	2.2	2 off	2 x 2



Dual 3+3

Key Benefits

- Carry out both wet and dry process in one machine
- Operator friendly controls
- Low maintenance
- Manual / Auto functionality
- British built high-quality product
- Quiet in operation





AWP188 Wheel Polishing Machine

Suitable for achieving a highly polished finish on wheels, the AWP188 machine has been designed to be simple to operate and to produce excellent results. To achieve a highly polished finish, wheels can go through 3 processing steps: cut down, smoothing and polishing.

Key Benefits

- Both automotive wheels & motor bike wheels can be finished.
- Great for polishing worn automotive wheels and other parts.
- Design includes system to clamp wheels with different sizes (up to 24" / 610 mm).
- Both forged and casted wheels can be processed.
- Reliable and repeatable finish each time.
- Low maintenance.
- Cost and time saving.
- Durable machine due to design, good quality materials and workmanship knowledge.



Key Features

- Wear resistant polyurethane lining.
- Stainless steel 90° dosing pump for dosing water and compound.
- Compact design.
- Drive system with sealed bearings for maintenance-free running.
- Standard control panel to control machine functions including isolator, on/off controls and timer.
- Speed control (optional).
- Pneumatic acoustic lid (optional).
- Polyurethane drain with 2mm holes.
- Stainless steel drain (optional).
- Pneumatic lifting system (optional).

Technical Specifications

Capacity		Overall dimensions in mm/ inch								Thickness of Polyurethane in mm / inch	Max Motor Rating (kW)	Machine Weight (kg)
Cu. Ft.	Litres	A	B	C	D	E	F	G	H			
6.6	188	1366 / 54	920 / 36	830 / 33	950 / 37	1050 / 41	720 / 28	475 / 19	920 / 36	15 to 25 / 0.6 to 0.9	2 X 11 / 1500	450

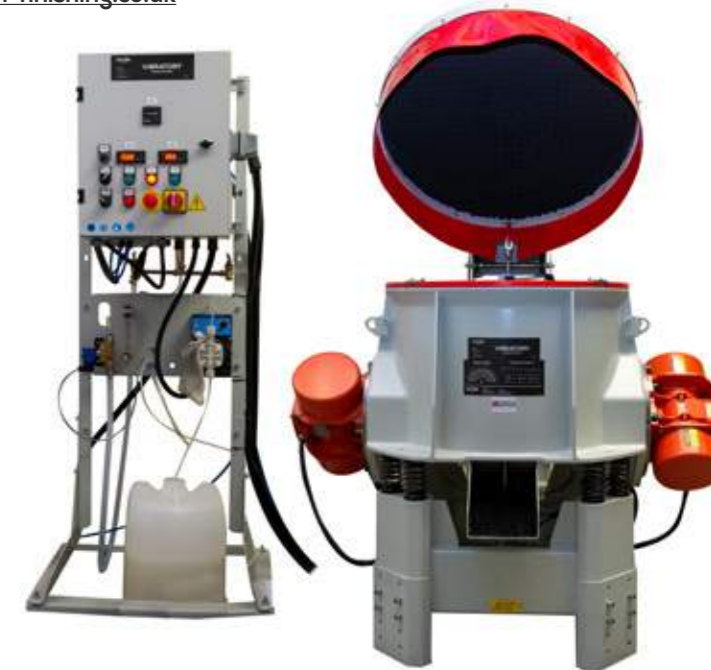

Step 1: Cut Down



Step 2: Smoothing



Step 3: Polishing



Centrifugal Disc Finishing Machine

The Centrifugal Disc machine is perfect for processing small and thin components as well as larger parts with a length of 150mm. These machines are recommended for processing small to medium batches of parts.

How it works?

The spinning motion of the disc machine is given by the disc situated at the bottom of an open barrel. The rotating disc makes the media, compound and parts to move in a rolling motion, resulting in effective finishing process in the shortest time. To achieve the desired finishing results it is important to set up the machine RPM, the compound and water mix flow and to use the correct media.

Technical Specifications

Model	DTB-50	DTB-100	DT-20	DT-50	DT-100	DT-230
A mm/ inch	965/ 37.9	1035/ 40.7	1045/ 41.1	965/ 37.9	1035/ 40.7	1350/ 52.7
B mm/ inch	750/ 29.5	990/ 38.9	530/ 20.8	750/ 29.5	990/ 38.9	1320/ 51.9
C mm/ inch	1235/ 48.6	1385/ 54.5	1175/ 46.2	1235/ 48.6	1385/ 54.5	1600/ 62.9
D mm/ inch	980/ 38.5	1085/ 42.7	900/ 35.4	980/ 38.5	1085/ 42.7	1370/ 53.9
E mm/ inch	585/ 23.0	580/ 22.8	610/ 24.0	585/ 23.0	580/ 22.8	700/ 27.5
F mm/ inch	520/ 20.4	600/ 23.6	360/ 14.1	520/ 20.4	600/ 23.6	860/ 33.8
G mm/ inch	460/ 18.1	560/ 22.0	330/ 12.9	460/ 18.1	560/ 22.0	800/ 31.4
H mm/ inch	350/ 13.7	420/ 16.5	290/ 11.4	350/ 13.7	420/ 16.5	480/ 18.8

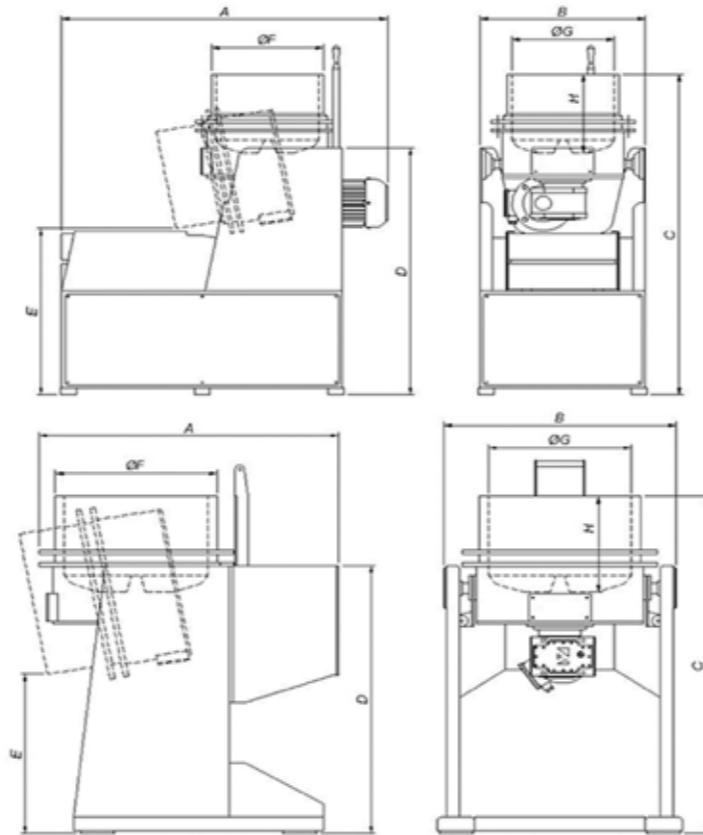

Series	Model	Gross Volume Litres	Net Volume Litres	Max Motor Power		Voltage	Machine Weight (kg)
				kW	rpm		
DTB	DTB-50	50	38	5.5	260	380/ 50	380
	DTB-100	100	76	7.5	210	380/ 50	650
DT	DT-20	20	16	1.1	340	380/ 50	160
	DT-50	50	38	2.2	260	380/ 50	300
	DT-100	100	76	4.0	210	380/ 50	520
	DT-230	230	174	7.5	180	380/ 50	1100

Key Benefits

- Efficient in operation
- Faster than vibratory finishing machines
- Operator friendly controls
- Low maintenance
- Good value for money as it implies a reduced capital investment
- DTB series for heavy duty applications such as steel ball burnishing

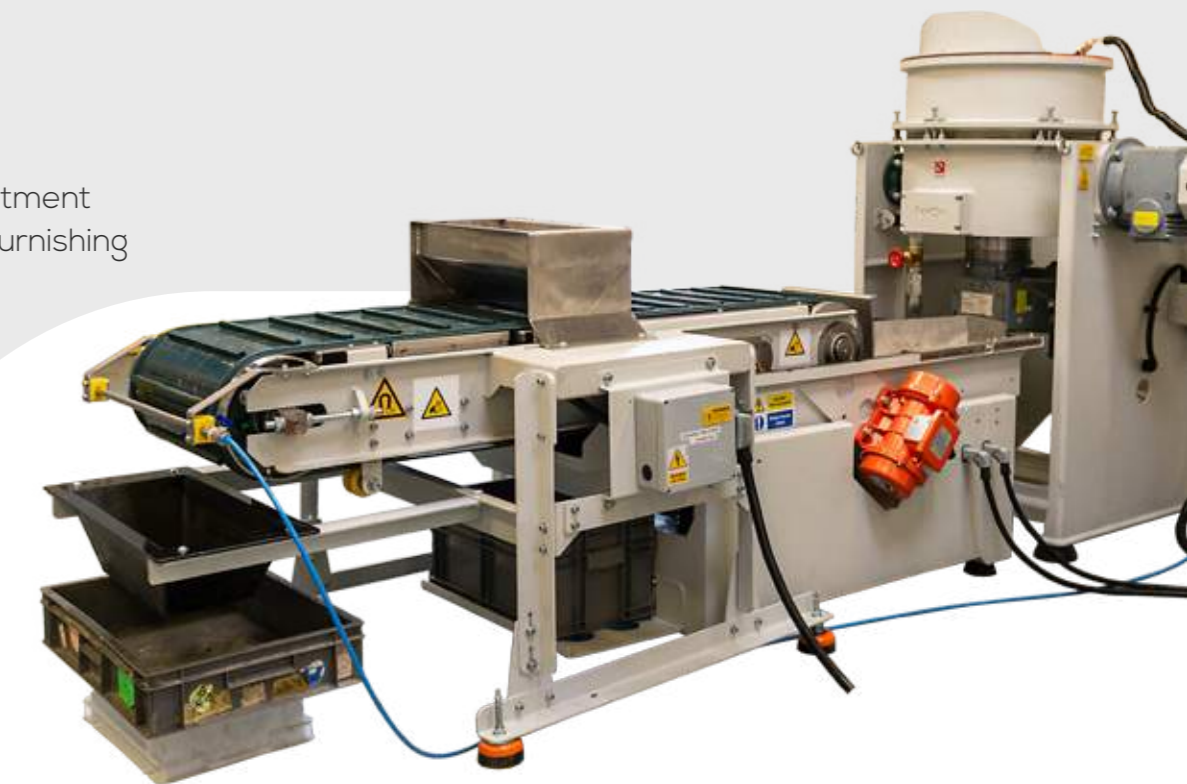

Key Features

- Manual and auto gap area adjustment functionality
- Temperature sensor to detect high temperature and protect the gap area
- Stainless steel upper and lower ring for higher wear resistance
- Manual/ auto functionality



Click [here](#) to download our Centrifugal Disc Finishing brochure for further technical information.



Centrifugal High Energy Finishing Machine

ActOn's Centrifugal High Energy Finishing machines are possibly the most efficient of the finishing systems available in the industry. These machines generate a very high gravitational force and are designed to perfection and engineered to maximise output.

These machines enable faster finishing of the parts, while ensuring high quality of the finishing component. With a variety of applications, the CPM and CHE series can give you an aggressive cut-down; yet it is precise enough to give a mirror shine to most of your delicate components.

Technical Specifications

Model	Capacity		No. of Barrels	Barrel Shape	Overall dimensions in mm/ inch			Barrel Size in mm / inch (with liners fitted)		Max Motor Rating (kW)	Max Barrel Speed (RPM)
	Cu. Ft.	Litres			Length	Width	Height	Hexagonal Barrel	Circular Barrel		
CPM10	0.35	10	4	Hexagonal or Circular	1080 / 42.5	875 / 34.4	1700 / 66.9	136 x 129 / 5.4 x 5.1	157 x 129 / 6.2 x 5.1	1.1	225
CHE30	1.05	30	4	Hexagonal	840 / 33.07	1040 / 40.94	1575 / 62.01	173 x 292 / 6.81 x 11.49	N/A	3.75	250
					Width x Length x Height						
CHE40	1.41	40	3	Hexagonal	1220 / 48.03	1570 / 61.81	1560 / 61.41	180 x 480 x 208 / 7.08 x 18.89 x 8.18		4.0	225
CHE50	1.88	53.5	4	Hexagonal	1230 / 48.42	2000 / 78.74	1950 / 76.77	180 x 480 x 208 / 7.08 x 18.89 x 8.18		5.5	175
CHE80	2.82	80	4	Hexagonal	1270 / 50	1640 / 64.56	2700 / 106.29	215 x 520 x 248 / 8.46 x 20.47 x 9.76		5.5	150
CHE240	8.47	240	4	Hexagonal	1720 / 67.71	1740 / 68.50	3050 / 120.07	365 x 693 x 422 / 14.37 x 27.28 x 16.61		11.0	125



CHE40

Key Benefits

- Shorter processing time than traditional methods
- High polishing efficiency
- High or low rate of stock removal
- Significant reduction in surface roughness
- Gentle action on parts
- Greater control of the process
- No need for fixturing or tooling
- No part impingement
- Easy to maintain
- Operator friendly
- Option to carry out different processes in each barrel
- Availability of automated systems
- British built, high-quality product

➤ Click [here](#) to download our CHE brochure for further technical information.



Part before and after CHEF finishing



CPM10



Key Features

- Critical components heat-treated for added durability.
- PLC controlled, with maintenance alerts, unbalance weight detection & 100 recipe programs.
- Greater control of the process.
- Wear resistant polyurethane liners. Liners available with dividers to avoid damage of parts. Removable liners.
- Removable barrels (CPM10, CHE30).
- Pressure release valves on barrels.
- Incorporates the spider plate technology for added thrust for processing of parts.
- Geared motor for barrel tilting mechanism for automatic unloading (CHE40/ 50/ 80/ 240).

Waste Water Treatment

The process of wet mass finishing generates a discharge of the processing liquid, which comprises of metal fines, abrasives, compound and in some instances, oil due to the condition of the parts. We suggest having a suitable treatment system in place as a responsible measure towards the environment and also to facilitate recycling in certain applications and to reduce processing costs.

AAC-36 Automatic Centrifuge

The ActOn AAC-36 Centrifuge allows for treating of waste water discharged from finishing machines. Using cost effective methodology, it provides efficient effluent treatment by removing the solids before discharge into drain, and water recycling to be further used in finishing processes.



MADE IN BRITAIN

ABC01 Batch Centrifuge

The ActOn batch centrifuge comprises of a mechanical centrifuge, recycling tanks and pumps. The unit is designed to work in the most effective manner to treat the discharge water from mass finishing, either suitable for recycling or discharge to the foul drain as dictated by the process. The solids are captured in the basket of the centrifuge and then disposed of based on country specific regulations.

- Easy to replace sludge collection basket.
- Effluent tank with complete drain ability.
- Recirculation tank for collection and storage of recycled / fresh water.
- User friendly control system with/without PLC Controls.
- ActOn centrifuge has been designed to be connected to 3 VB10/VB10S machines, the pumps being operated through PLC. It is advised that all 3 machines use the same chemical.
- Ease of adding clean water and new compound is provided to maintain the required concentration in the recirculation tank.



Recirculation Tank

ActOn's recirculation tank is a highly cost-effective solution when processing small quantities of effluent. While the effluent from the finishing machine is discharged into the recirculation tank first chamber, the fine particles such as media and metal fines are captured by a stainless steel filter and the clean water is transferred into a second chamber.

Key Features

- Recirculation tank can be offered with a pump designed to recycle the clean water into the finishing system
- Chambers can be easily accessed to clean the sludge (the amount of times the tank has to be cleaned depends on the amount of solids the finishing system generates)
- Durable product due to design, good quality materials and workmanship knowledge
- Approx. dimensions in mm / inch (L x W x H): 1211 x 654 x 760 / 47.6 x 25.7 x 29.9



Settlement Tanks With or Without Pumps

The settlement tank is connected to the drain of the finishing machine and the effluent is discharged from the vibratory machine into this tank. The solids which settle out in the tank chamber can be removed with ease by the operator with the removable baskets. The Settlement tank is available in painted or stainless steel versions. The Settlement tank is available in the following standard dimensions (mm /inch):

- 1170 (L) x 620 (W) x 560 (H) / 46.1 (L) x 24.4 (W) x 22 (H)
- 900 (L) x 365 (W) x 335 (H) / 35.4 (L) x 14.4 (W) x 13.2 (H)

Click [here](#) to download our Waste Water Treatment brochure for further technical information.



Accessories

Each of our accessories is simple to operate, highly efficient and has been designed to complement ActOn's vibratory and centrifugal high energy finishing machines.

Accessories we provide

For vibratory finishing: dosing units, control panel, separation systems, air knife, dewatering screen, compound mixing tank, dust extractor, acoustic lids, feeders and hoppers, rotary table, divider plates, part fixture and media recirculation systems, portable media screening unit.

Accessories for high energy finishing machines: automated media or part return system, automated dosing control, PLC & HMI controls, spare barrels, vibratory separation system, unload chute system and liners.

Click [here](#) to download our Accessories brochure for further technical information.



Key Benefits

- British high-quality product.
- Durable products due to design, good quality materials and workmanship knowledge.
- Easy to operate.
- Low maintenance.
- Can be easily integrated with ActOn's automated systems.



Auto Deburr & Polishing System

This system incorporates 2 vibratory bowl finishing machines with a pneumatic unload system and it has been designed for customers manufacturing a variety of tools to suit the layout and operation.

The first machine has a clockwise unload, while the second one has an anti-clockwise unload. The height of both machines has been adjusted to enable components being unloaded from the first bowl into the second one.

The design of the system enabled the customer to carry out a 2 stage process with no operator intervention.

System Benefits

- Customised design.
- Auto functionality helps carry out production out of hours.
- Multiple process stages.
- Full control of process with minimum reliance on operator.
- Suited to small and large volumes of parts.
- Can be used as a continuous or batch system.
- Savings in operating costs.

Left Hand Configuration

Process time is set for this machine to deburr the parts. At the end of the process, the machine stops and reverses the media and components to allow the separation flap to engage - thus ensuring no entrapment of parts and media under the separation flap. A complete unload and separation of parts from media is achieved automatically and components are discharged to the next sequence of the process.



Right Hand Configuration

Upon completion of the polishing process the separation flap is engaged pneumatically, allowing vibration to unload the parts over the separation screen. The media falls through the separation screen and returns into the bowl, while the parts are unloaded from the machine and suitably collected.

Automation: Linear Trough

The ActOn Linear Trough Series machine is unique in design and meets the highest standards. It is a through feed machine with automatic media return. The parts are fed from one end and discharged from the other end making this equipment suitable for continuous output.

Components requiring deburring and descaling are - either manually or via an auxiliary system - fed into the vibratory trough. The parts travel all along the length of the trough with a mixture of compound fed from the recirculating tank that is built as an operator platform and media to deburr and descale parts post heat treatment. At the end of the trough there is a vibratory screening system to separate the parts from the media. The media is transferred back to the work chamber via the conveyor and a feeder. Control system could be either PLC with HMI or Push buttons.

Vibratory Separation System

Upon completion of the process, parts and media are slowly fed into the vibratory system. The media falls through the separation screen and returns into the feeding end via the media conveyor, while the parts are unloaded from the machine.

Media Return Conveyor

This has been integrated to carry the media from the vibratory media feeder into the finishing machine. The main advantage of the conveyor is that it reduces the manual handling, hence reducing the time spent to load the machine.

Vibratory Linear Trough Finishing Machine

The machine capacity is 785L. The process chamber has a hot, cured polyurethane lining and is used to deburr, descale, radiusing and cleaning the parts. To control the speed of the media and parts, a flow control system has been installed. The unload of the components is made through a vibratory separation system.

PLC

PLC to control the system. Offers the option to pre-set recipes for processing the parts.

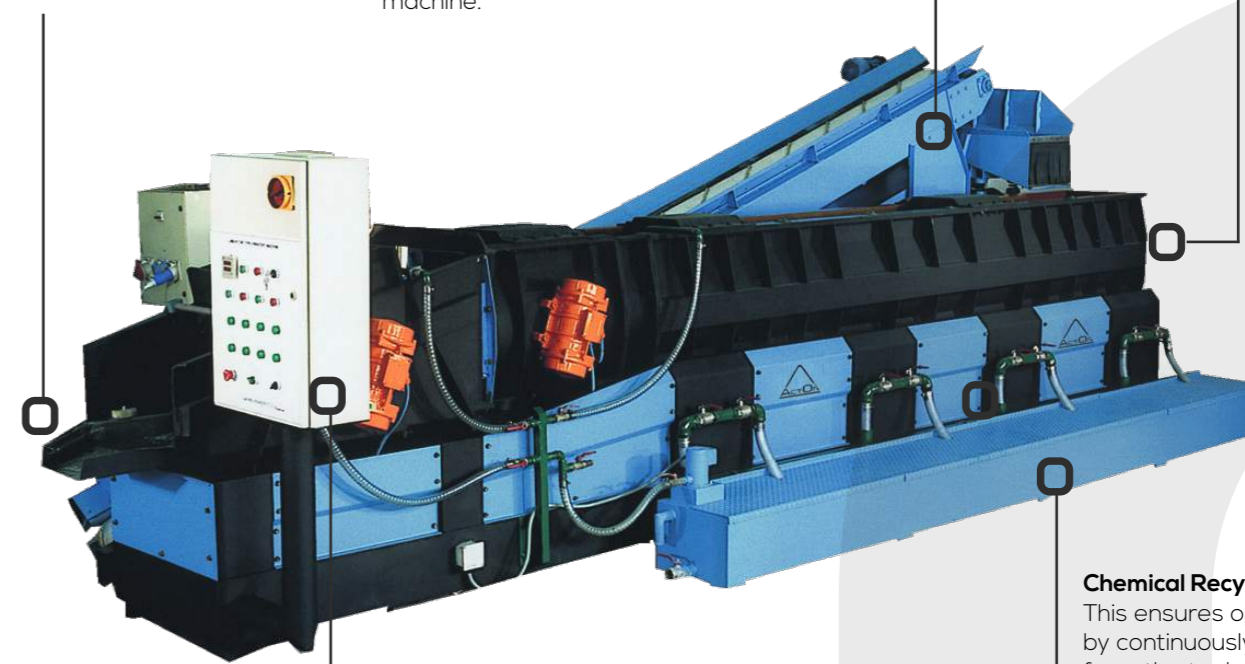

Chemical Recycling Tank/ Operator Platform

This ensures optimum usage of chemical compounds by continuously recycling the compound into the bowl from the tank. A combination of pump and valves control the recycling process. The tank has been designed to also be used as a platform for ease of access to the work chamber.

VB10P Vibratory Finishing System

This Vibratory Finishing System has been designed to ensure 100% unload of media and components from the finishing machine, while reducing manual handling and achieving a consistent finish every time. This vibratory system is controlled via a HMI/PLC allowing the operator to set up the process parameters and easily control the process. Once the process starts, a set batch of parts are loaded into ActOn vibratory finishing bowl via a conveyor.

At the end of the process the bowl's pneumatic media door opens allowing the parts and media to be discharged in a storage hopper. This stage ensures 100% unload of media and components from the finishing machine. After the parts and media have been unload the pneumatic door closes to allow a new finishing process to begin.

The system also includes a vibratory separator which enables the separation of parts from media. The undersized media falls through a separation grid and is filtered from the system, while the rest of the media returns into the vibratory bowl through a conveyor. The finished components are transferred from the vibratory separator to a conveyor and discharged in the packing area.

VB10P Vibratory Bowl

Designed with pneumatically operated door to allow the parts and media to be 100% discharge from the bowl at the end of the finishing process.

Parts Conveyor

Facilitates transfer of components for the next process.

Media Conveyor

Media returns into the vibratory bowl through the media conveyor.

Vibratory Separator

To separate media and parts after the finishing process.

Dosing Unit

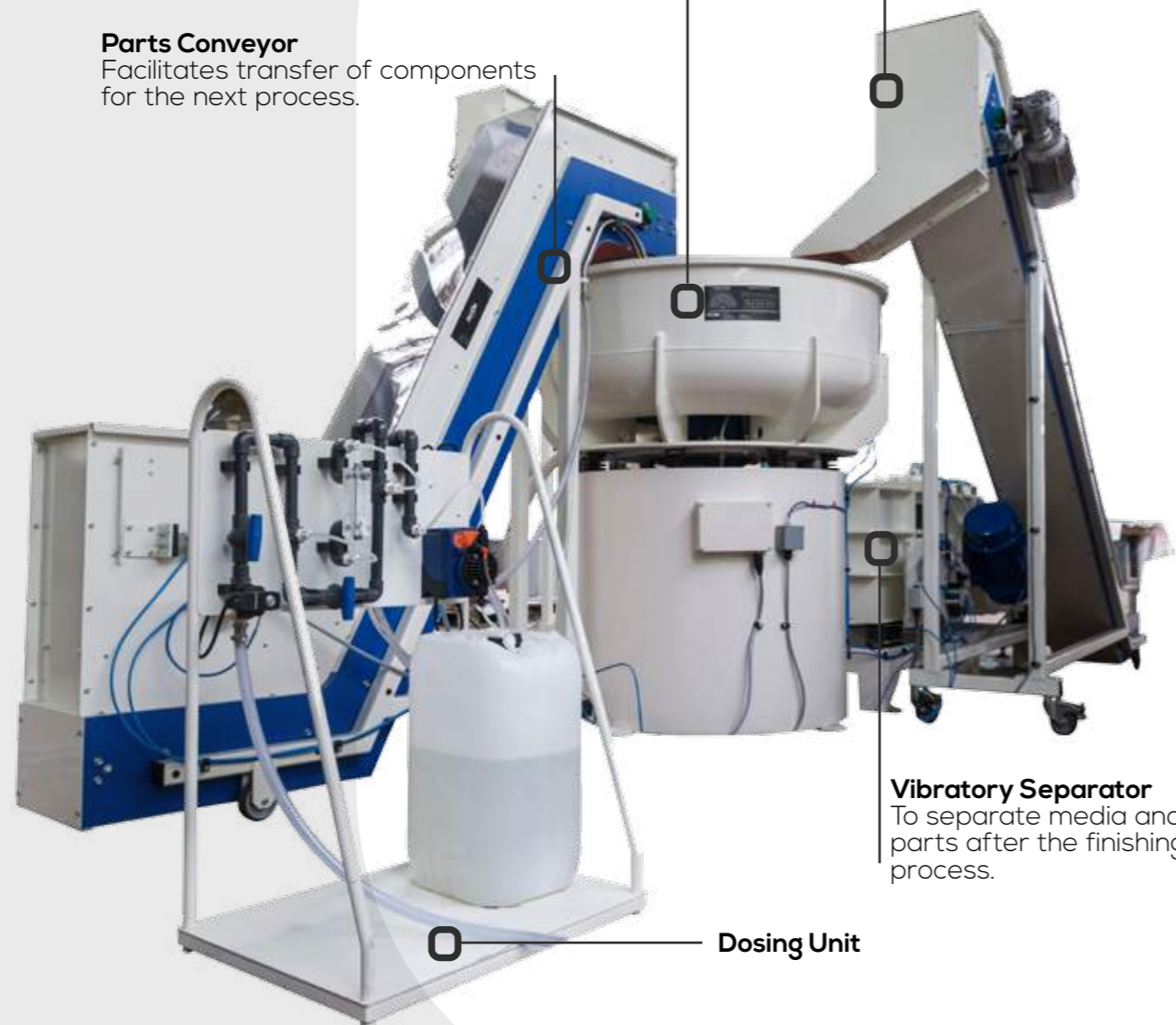

DTB-50 Finishing System with Automatic Magnetic Separation

This ActOn Disc Finishing system is unique in design and meets the highest standards required by industry. The design allows continuous output: while the finished batch of components are separated from media and discharged, a new batch is being processed in the disc finishing machine. The process is fully automated and controlled from the point of parts being processed to the discharge of the parts.

Due to the size of components and media being very similar, parts are separated 100% magnetically and are demagnetized prior to being discharged in the collection tray.

System Benefits

- Equipments configuration results in seamless and controlled processing.
- Operator intervention is minimal.
- Measured throughput to avoid excessive loading & controlled process.
- Repeatable process via recipe control.
- Customised to user requirements.
- 100% separation of parts and media.

Parts Conveyour

Conveys the parts from the vibratory separator to the parts collection tray through the demagnetiser.

Parts Hopper

The parts hopper allows for the parts to drop into the parts collection tray without spilling.

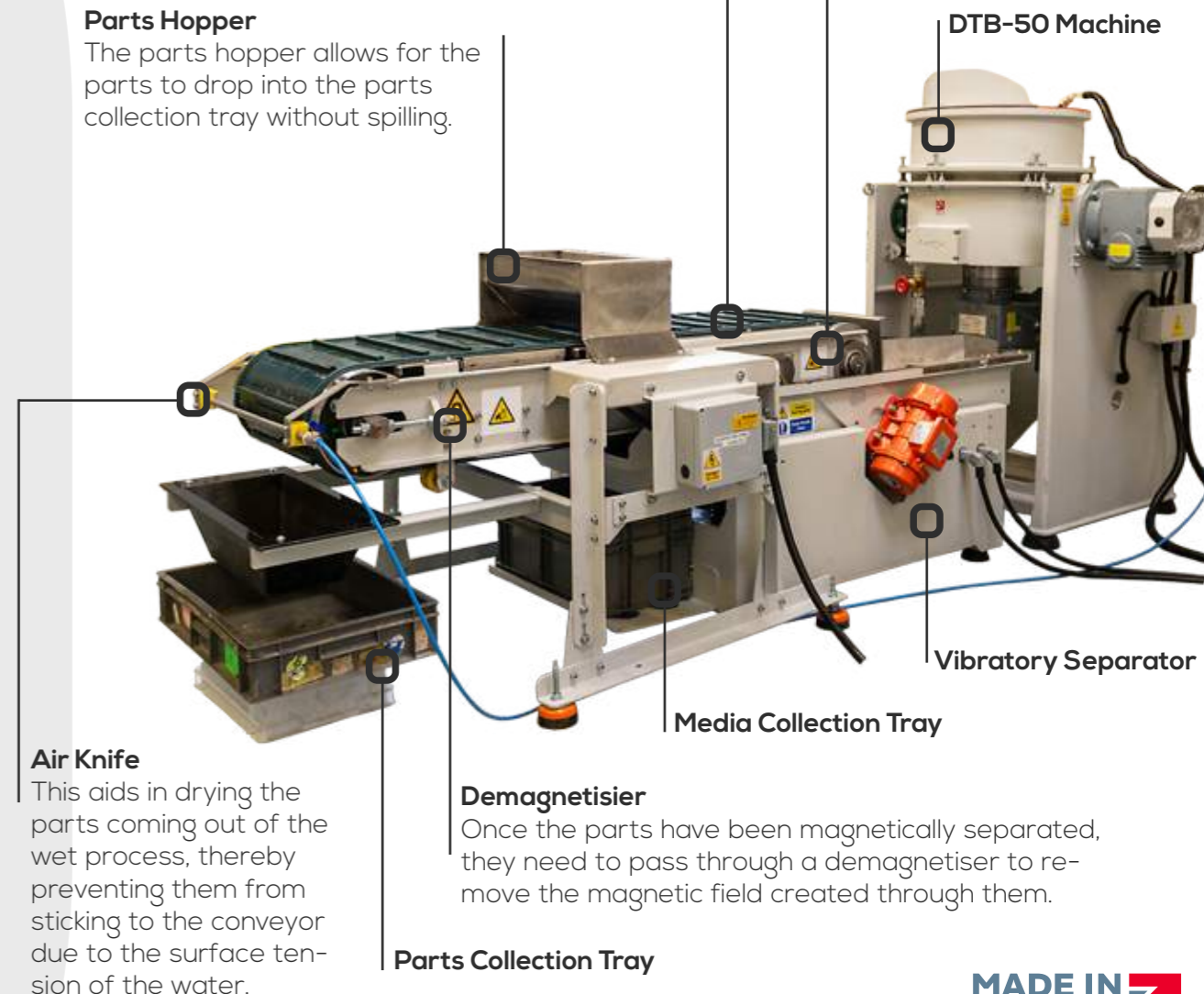

Air Knife

This aids in drying the parts coming out of the wet process, thereby preventing them from sticking to the conveyor due to the surface tension of the water.

Demagnetiser

Once the parts have been magnetically separated, they need to pass through a demagnetiser to remove the magnetic field created through them.

Magnetiser

Allows separation of parts from the media after the finishing process. While media & compound mix go through the vibratory separator, parts are carried through the parts conveyour.

DTB-50 Machine

Vibratory Separator

Media Collection Tray

Parts Collection Tray

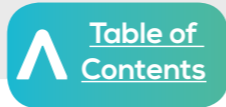

Automation for High Energy Finishing Machines

We designed and built this CHE50 System to degrease and remove sharpness on Molybdenum parts, before the plating stage in a more effective way. The system is HMI/ PLC controlled and it includes 100 finishing recipes which makes the machine easy for the operator to use.

High Energy finishing can be 15-20 times faster and produces superior finishes. This process time advantage meant that our customer was able to process 10,000 parts in one hour, in comparison with 8,000 parts in 9 hours (result obtained by customer inhouse using traditional barreling methods).

To make the finishing process even more efficient, we integrated in the High Energy system, a Vibratory Separation System. Upon completion of the process, parts, media and the mix of water and compound are discharged from the barrel into the vibratory separation system and separated via the screen.

The Result

- Our finishing process enabled our customer to process 10,000 parts in 1 hour, in comparison with 8,000 parts in 9 hours.
- The trials showed a 98% pass rate compared to an average of 93% using the previous finishing process.
- The finishing process produces a repeatable and high quality finished product.

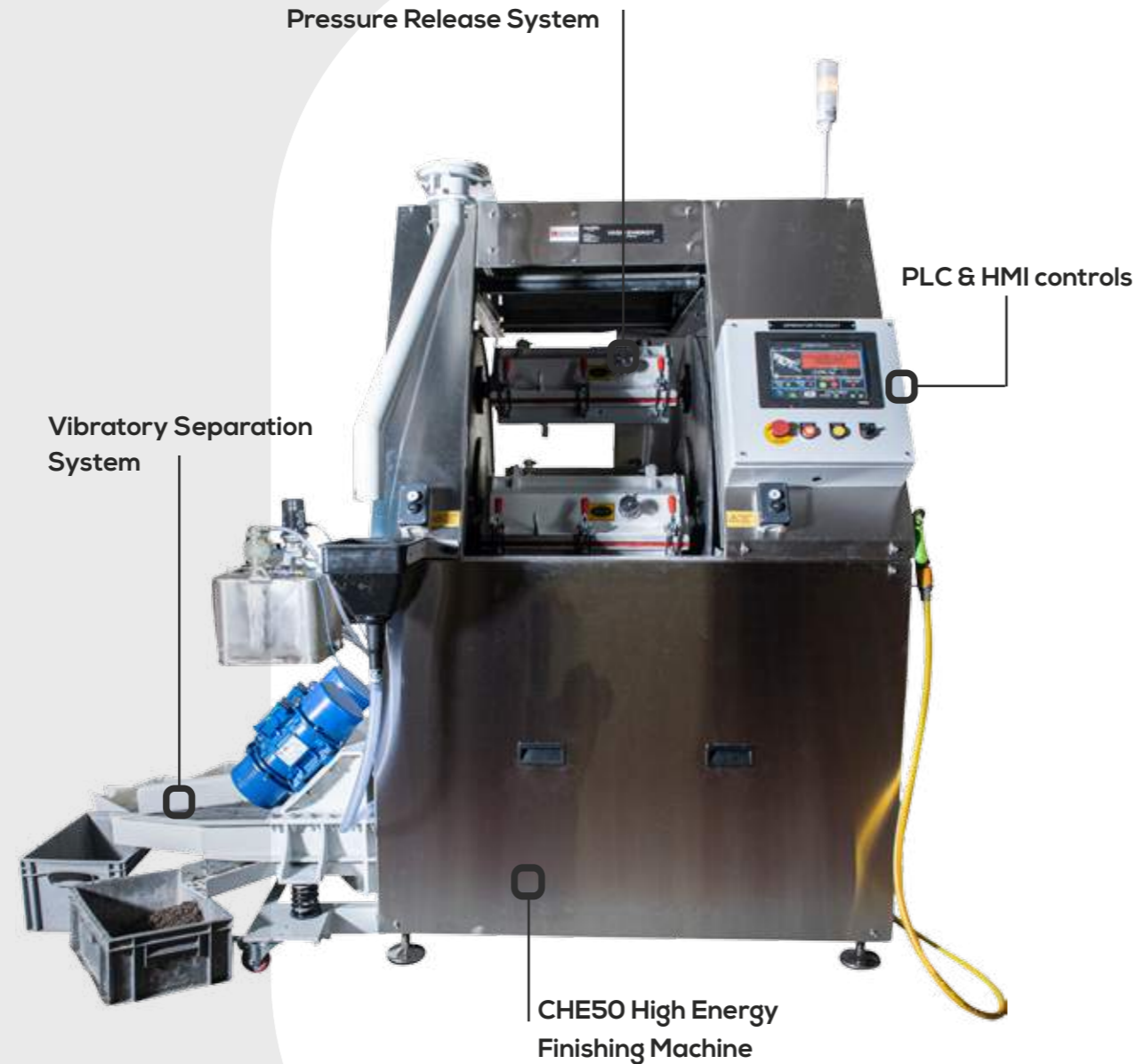

Semi-automated Centrifugal Disc Finishing Machine



Auto Deburr/ Polish and Media Recirculation System



Cutlery Polishing and Drying System

CHE240 Automated System





DLyte Electropolishing

A New Concept of Polishing

ActOn Finishing is an authorised distributor of the DLyte® technology. This technology is developed and manufactured by GPAINNOVA, Spain, for grinding and polishing metals by ion transport using free solid bodies. DLyte® is revolutionising the dry electro polishing technology as it doesn't use any liquid as electrolyte.

Click [here](#) to download our DLyte brochure for further technical information.



The DLyte® machine achieves high quality finishing for machined, sintered and casting parts, obtaining a mirror finish result. The polishing action reaches every corner of the piece, so it can process inner cavities which can not be accessed mechanically.

Finishing Solution for a Wide Range of Materials

DLyte® systems use a polishing media which consists of solid particles (electrolyte) of different sizes. Thanks to the wide variety of electrolytes, DLyte® provides a solution to the most common metals and alloys in the industry, such as Cobalt Chrome, Stainless Steel, Carbon Steel, Nickel Alloys, Copper Alloys, Titanium and Nitinol.



Key Features

- Maximum size of part to be processed: 180 Ø x 80mm
- Programmable cycle time.
- Automatic parameter adjustment.
- Automatic media conductivity adjustment
- Variable motors speed and movement.
- Digital interface.
- Customizable settings.
- Process data can be loaded/unloaded onto external

- USB storage drive.
- Ergonomic loading and unloading of holder.
- Quick and easy change of media.
- Anti-vibratory support with wheels for easy handling.
- Easy and low maintenance costs.
- Very low noise emissions thanks to the acoustic insulation system.
- No dust emission.
- CE certificate

Key Benefits

- Allows an easy processing through the channels and cavities.
- Achieves homogeneous results across the surface and eliminates any micro-scratches.
- Respects the tolerances and preserves the initial shape, even the cutting edges.
- Achieves an Ra under 0,09 micrometres.
- Helps to achieve negative surface skewness (rsk) which increases the surface bearing contact area (allowing uniform lubricant film distribution).
- Avoids generating grinding texture patterns.
- Improve resistance to part wear and fracture resistance.
- Improves the bearing ratio and fatigue resistance.
- No contamination on the surface and no traces of hydrogen on the surface.
- Increases resistance to corrosion.
- Controlled costs and predictable lead times.

Technical Specifications

Model	DLyte 1l	DLyte 10l	DLyte 100l
Capacity	75Ø mm x 50 mm	120Ø mm x 50 mm	180Ø mm x 80 mm
Machine Dimensions	500 x 555 x 1145 mm	820 x 640 x 1220 mm	950 x 690 x 1410 mm
Support Dimensions	-	820 x 1025 x 750 mm	950 x 1040 x 700 mm
Machine Weight	96 kg	173.5 kg	217.5 kg
Support Weight	-	87 kg	100 kg
Power	2 kW	3 kW	5 kW
Voltage	220-240 V or 110-115 V	220-240 V or 110-115 V	220-240 V or 110-115 V
Air Pressure	-	4-5 bar	4-5 bar
Bucket Volume	6 Litres (Electrolyte)	9 Litres (Electrolyte)	16 Litres (Electrolyte)



DLyte Desktop Pro

All the features from a DLyte machine, available in an ultra-compact system. This equipment has been designed to allow any manufacturer, workshop, workroom and SMEs, who would require a cost-effective solution for metal surface finishing, to use the dry electropolishing technology.

How it works?

DLyte Desktop PRO works by combining the electrical flow created by the high precision rectifier with the movement of the pieces through the electropolishing media. This results in an ion exchange, removing material only from the peaks of roughness. The process does not round edges and can access internal corners that are not easily accessed mechanically.



Key Benefits and Features

- Consistent surface finishing results every time.
- Combines the performance of DryLyte technology with the ease of a plug-and-play system
- Affordable finishing solution.
- Pre-set settings and opt-in advanced controls.
- Does not require special installation.
- It operates with a standard household electrical plug.
- Deduced loading and unloading times due to the holder fixation system with easy pressure and automatic locking system.
- Includes an advanced and intuitive interface.
- Space-saving as it can be operated on top of a table of 465 mm x 465 mm.
- Smooth and silent in operation.
- The automation of surface finishing with DLyte Desktop PRO protects the technician from the exposure to the chemical agents at work.
- Easy to maintain
- Achieves an Ra under 0,01 micrometers
- CE certificate.

[Click here](#) to request a quotation today!

DLyte Finishing Applications



Healthcare
Industrial
Aerospace
Automotive

Implants, Instrumentation, Prosthetic Parts, Hearing Aid, Needle
Moulds, Dies, Industrial Precision Parts, Cutting Tools, Engine Parts, Watch Case
Blisks, Stators, Blades, Manifolds, Brackets, Guide Vanes, Bearings, Gears
Impellers, Shafts, Gears, Bearings, Joint balls, Fuel Injectors, Brake parts, Luxury Inserts

CNC/ INOX 316L



Surface Roughness Before:
Ra 0.692 μm | Rz 3.626 μm

Surface Roughness After:
Ra 0.125 μm | Rz 0.843 μm



Shot Blasting Cabinets

We offer a range of Shot Blast Systems to help our customers achieve the surface finish they need every time. Whether you require to descale, remove corrosion, mill scale, paint or rust, achieve a smooth finish, deflash, polish or strengthen the metal we will offer you full support every step of the way.

Click [here](#) to download our Shot Blasting brochure for further technical information on ActOn Shot Blasting Machines.



Mobile Blasting Systems

Our Portable Blasting Series includes 3 models: Powertrack Junior, Powertrack and a Mobile Blast Room. These blasting machines will offer the perfect balance between productivity and portability. Some of the main advantages of the portable Blasting Series include:

- Are designed for a wide range of applications, including metal and stone finishing.
- Very economical and easy to operate.
- Easy to move.

ActOn Powertrack Junior

ActOn Powertrack Junior has been designed to allow customer to easily blast in different locations. This blasting machine works on the pressure tank principle and is connected to compressed air and 230V electricity and delivers you mobile, dust-free blasting on a lower budget. The Powertrack Junior is perfect for blasting work in stonemasonry, shipyards and maintenance services.

Key Features and Benefits

- For metal and stone blasting applications.
- All components are assembled into one compact unit.
- The suction blast head consists of blast nozzle, head with brush and handle.
- Length of the hose set is 4 meters.
- Different brushes are available.
- Suitable for blasting inside and outside corners.
- Dust-free blasting process.
- The blast vessel is equipped with an automatic pressure relief valve.



Technical Specifications

	Powertrack Junior
Overall Dimensions in mm/inch (L x W x H)	906 x 579 x 1294 / 35.6 x 22.8 x 51
Boron carbide blast nozzle	ø 4 mm
Vacuum cleaner power	Max 1,6 kW
Vacuum cleaner capacity	150 m ³ /h
Vacuum cleaner under pressure	120 mBar (= 30 kPa)
Power Supply	230V/50Hz
Air consumption at 3 bar and 4 mm nozzle	± 500 lt./min
Connecting pressure	4-5 bar, max 10 bar
Approx cabin weight in kg	65
Colours powder coating	Safire blue (= RAL 5003)

ActOn Powertrack

ActOn Powertrack is a mobile and economical pressure blasting solution. This blasting machine can be used with different types of fine-grained media. The ergonomic design and the application of advanced components in a compact construction guarantees a perfect system. The effective blast head and efficient abrasive cleaning ensure optimum abrasive efficiency.

Key Features and Benefits

- All components are assembled into one compact unit.
- Ergonomic design.
- Blasting media can be reused.
- PLC controlled.
- Complete with cyclone, extraction and automatic filter cleaning.
- Dust-free blasting process.
- The suction blast head includes the blast nozzle, head with brush and handle.
- Available with aluminium head for blasting surfaces and stone head for engraving stone
- Length of the hose set is 5 meters.
- Different brushes are available.
- Suitable for blasting inside and outside corners.
- The cyclone ensures perfect blast media cleaning and a constant operating mixture.
- The cyclone is equipped with a wear resistance lining.



Click [here](#) to download our Shot Blasting brochure for further technical information

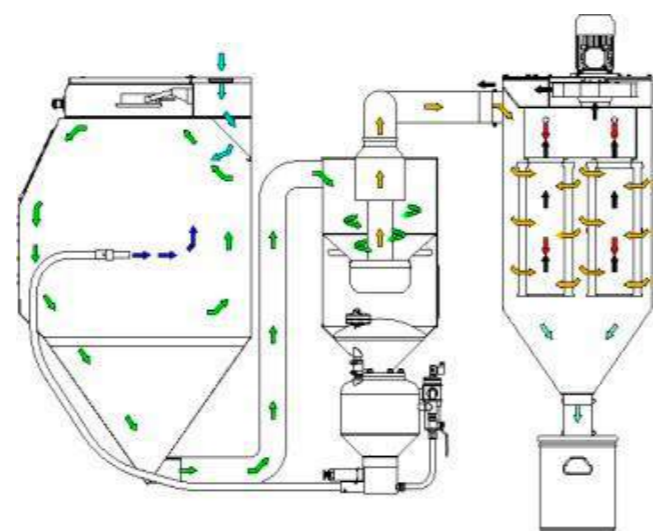

Technical Specifications

	Powertrack
Overall Dimensions in mm/inch (L x W x H)	1413 x 1026 x 1810 / 55.6 x 40.4 x 71.3
Boron carbide blast nozzle	ø 6,3 mm (stone head) or 8 mm (aluminium head)
Filter cartridges (polyester, M-class)	2 filter cartridges of 4 m ² (=8 m ²)
Capacity ventilator	310 m ³ /h (3 kW)
Dust emission	< 1,8 mg/ Nm ³
Power Supply	3 x 400V, 50 Hz, earth and zero
Total power consumption	3,2 kW
Connecting pressure	± 3.000 lt./min
Approx cabin weight in kg	350
Colours powder coating	Safire blue (= RAL 5003)



How it works?

Switch on the blasting machine and set up the blasting pressure. Place the brush head on the surface that needs to be blasted and turn on the gun safety switch. The abrasive is blasted onto the product and directly extracted through the brush head. The large-sized filter ensures that the emission remains well below the NER guidelines. Partly due to the automatic filter cleaning, maintenance is very limited and manufactured for long, trouble-free use. This results in dust-free blasting, without the use of a cabin. By reusing the blast abrasives, this pressure blasting unit delivers a high efficiency of the blasting medium and saves the costs.



ActOn Mobile Blast Room

The ActOn Mobile Blast Room includes a mobile shot blasting container and the LP2500 unit. The system is fully integrated with a blast vessel, media reclaim system with cyclone and a filter with automatic filter cleaning. The entire unit can be easily transported with standard transportation. After a quick installation, you can start blasting without the need for additional structures.

Key Features and Benefits

- Easily transported with standard transportation.
- Rapid installation, making immediate blasting possible.
- The blast room is set up with a flat steel floor, suction pit, PVC protective lining, lighting and air cleaning system.
- The walls of the blast room are made of sandwich panels to reduce noise.
- Blast room can also be equipped with extra access door, rubbing plate and scraper floor. (optional)
- The cyclone ensures perfect blast media cleaning and a constant operating mixture.
- The cyclone top is inside lined with wear resistant Linatex.
- Integrated filter unit with mid pressure ventilator, five filter cartridges and pressure vessel with automatic cartridge cleaning.
- PLC controlled.

How it works?

After the system is switched on the blasting can start with a dead man's switch on the blast nozzle. The pop-up in the blast vessel closes, the dosage valve is opened and the blasting starts. Dust is sucked out of the blast room. After blasting the system is switched to media recuperation. The dust and contamination is removed from the blasting media in the cyclone. Dust is removed in the filter. Dust collection is in a sealed dust bin. The filter is cleaned automatically via reverse air pulses.



Blast Container

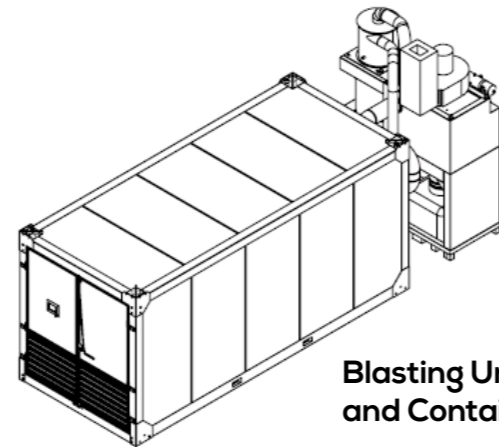

Blasting Unit and Container



Blast Container

Technical Specifications

LP2500 Blasting Unit

External dimensions in mm/inch (L x W x H)	2400 x 1350 x 3480 / 55.6 x 40.4 x 71.3
Filter cartridges (polyester)	5 filter cartridges of 13 m ² (=65 m ²)
Capacity ventilator	2500 m ³ /h – 2500 Pa (5,5 kW)
Dust emission	< 2 mg/ Nm ³
Membrane valves for cartridge cleaning	3 pieces 24 V – 1 inch
Pneumatic connection	1 1/4 inch supply tubing
Connecting pressure	6 – 10 bar
Blast nozzle (1 at choice included)	Type 6S32 (ø 6 mm) Type 8S32 (ø 8 mm) Type 10S32 (ø 10 mm)
Blast hose	1", 12 m included
Suction hose	ø 150 mm PU heavy duty, 5 m included
Power Supply	3 x 400V, 50 Hz, earth and zero, 32A
Total power consumption	7 kW
Approx. unit weight in kg	1100
Colours powder coating	Dark grey (=RAL 7015)

Blast Container

	External dimensions in mm/inch (L x W x H)	Internal dimensions in mm/inch (L x W x H)	Weight in kg	Lighting LED
10 Feet Container	3480 x 2480 x 2720 / 137 x 97.6 x 107	2940 x 2170 x 2360 / 115.7 x 85.4 x 92.9	1700	3 x 53W
20 Feet Container	6480 x 2480 x 2720 / 255.1 x 97.6 x 107	5940 x 2170 x 2360 / 233.8 x 85.4 x 92.9	2200	5 x 53W
6*3*3 m Container	6200 x 3360 x 3200 / 244 x 132.2 x 126	5630 x 3020 x 2850 / 221.6 x 118.8 x 112.2	2900	5 x 53W
12*3*3 m Container	12200 x 3360 x 3200 / 480.3 x 132.2 x 126	11630 x 3020 x 2850 / 457.8 x 118.8 x 112.2	4500	7 x 53W



LP2500 Blasting Unit



LP2500 Blasting Unit

ECO Shot Blasting Cabinets

The ECO Blasting Series includes an economical range of Suction Blast and Pressure Blast machines. These machines have been designed to allow you to minimise your investment while enjoying the benefits of a good quality shot blasting machine. Both the ECO MI Series (Suction Blast Cabinets) and the ECO MP Series (Pressure Blast Cabinets) are built to achieve a rapid and efficient finish.

Key Features and Benefits

- Rapid and efficient blasting.
- Blasting process free of interruption.
- Permanent visibility due to optimal circulation of air and dust filtering.
- Solid construction.
- Comfortable arm holes.
- Good dust sealing.
- Large viewing window.
- Loading via large doors.
- Adjustable blast pressure.
- Filtercartridge.

ECO MI Series

ECO MI is a professional and compact Suction Blast cabinet built to achieve a rapid and efficient finish.

[Click here](#) to download our Shot Blasting brochure for further technical information



ECO MP04 Blasting System



ECO MI02 Blasting System



ECO MP Series

ECO MP is a professional and compact Pressure Blast cabinet built to achieve a rapid and efficient finish.

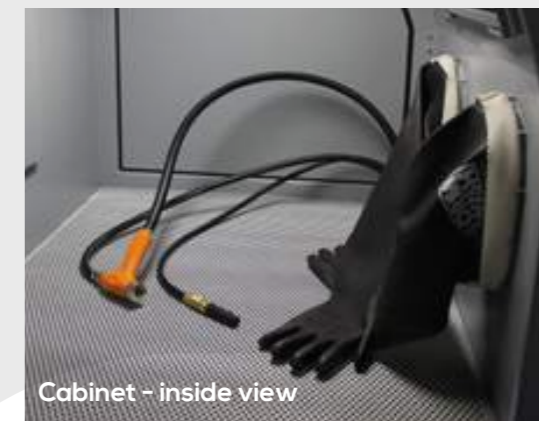

Cabinet - inside view



ECO Blasting System Turntable

Technical Specifications

	ECO MI 02	ECO MI 03	ECO MI 04	ECO MP 02	ECO MP 04
Blast Chamber Dimensions in mm/inch (W x D x H)	790 x 790 x 850 / 31.1 x 31.1 x 33.5	1100 x 800 x 850 / 43.3 x 31.5 x 33.5	1105 x 795 x 875 / 43.5 x 31.3 x 34.4	790 x 790 x 850 / 31.1 x 31.1 x 33.5	1105 x 795 x 875 / 43.5 x 31.3 x 34.4
Overall Dimensions in mm/inch (W x D x H)	925 x 1240 x 1980 / 36.4 x 48.8 x 77.9	1250 x 1280 x 1925 / 49.2 x 50.4 x 75.8	1225 x 1340 x 2095 / 48.2 x 52.7 x 82.5	925 x 1240 x 1980 / 36.4 x 48.8 x 77.9	1225 x 1340 x 2095 / 48.2 x 52.7 x 82.5
Working Height in mm/inch	900 / 35.4	860 / 33.8	825 / 32.5	900 / 35.4	825 / 32.5
Door Opening in mm/inch (W x H)	690 x 750 / 27.2 x 29.5	750 x 745 / 29.5 x 29.3	695 x 745 / 27.3 x 29.3	690 x 750 / 27.2 x 29.5	695 x 745 / 27.3 x 29.3
Machine Weight in kg	220	260	360	235	380
Illumination	20 Watt LED	20 Watt LED	20 Watt LED	20 Watt LED	20 Watt LED
Maximum Load in kg	350	350	350	350	350
Filter cartridge	1 x 4m ²	1 x 4m ²	1 x 21m ²	1 x 4m ²	1 x 21m ²
Power Supply	230V/50Hz/0.65 kW	230V/50Hz/0.65 kW	230V/50Hz/0.85 kW	230V/50Hz/0.65 kW	230V/50Hz/0.85 kW
Air Consumption	0,6-1,0 m ³ at 6 bar	0,6-1,0 m ³ at 6 bar	0,6-1,0 m ³ at 6 bar	±3,0 m ³ at 4 bar	3,0 m ³ at 4 bar

Premium Blast Cabinets

The Premium Blasting Series includes a range of Suction Blast, Wet Blast and Pressure Blast machines. These machines have been designed for blasters with high requirements when it comes to blasting results, user convenience, safety and environment. All components are assembled, according to ISO-certification, to create a compact turn-key unit.

DI Suction Blasting Cabinets

The DI Suction Blasting cabinets are equipped with a cyclone, which guarantees that the abrasive is cleaned perfectly. This results into less wear and better visibility. The suction blast pistol ensures, in combination with the mixing chamber, a constant optimum mix of pressurized air and abrasive, to offer an effective and efficient blasting process.

Key Features and Benefits

- Efficient powerful blasting.
- Blasting process free of interruption.
- Continuous clear view due to optimal circulation of air.
- Cabinet without foundations, compact construction.
- Efficient cleaning of abrasives by cyclone.

➤➤ Click [here](#) to request a quotation today!



Technical Specifications

	DI12	DI14	DP12	DP14	DP17	DP22
Blast Chamber Dimensions in mm/inch (W x D x H)	1105 x 800 x 800 / 43.5 x 31.5 x 31.5	1370 x 940 x 830 / 53.9 x 37 x 32.6	1170 x 940 x 885 / 46 x 37 x 34.8	1370 x 1040 x 940 / 53.9 x 40.9 x 37	1700 x 1400 x 1090 / 66.9 x 55.1 x 42.9	2200 x 1400 x 1090 / 86.6 x 55.1 x 42.9
Overall Dimensions in mm/inch (W x D x H)	1220 x 1275 x 2035 / 48 x 50.2 x 80.1	1485 x 1620 x 2191 / 58.4 x 63.7 x 86.3	1285 x 1520 x 2106 / 50.6 x 59.8 x 82.9	1485 x 1620 x 2191 / 58.4 x 63.7 x 86.3	1854 x 2073 x 2395 / 72.9 x 81.6 x 94.3	2350 x 2073 x 2395 / 92.5 x 81.6 x 94.3
Door Opening in mm/inch (W x H)	692 x 640 / 27.2 x 25.2	835 x 670 / 32.8 x 26.4	835 x 725 / 32.8 x 28.5	935 x 785 / 36.8 x 30.9	1265 x 925 / 49.8 x 36.4	1265 x 925 / 49.8 x 36.4
Working Height in mm/ inch	840 / 33.1	840 / 33.2	800 / 31.5	800 / 31.5	800 / 31.5	800 / 31.5
Approx. Machine Weight in kg	380	480	550	705	1180	1430
Illumination	1 x 20 Watt LED	1 x 20 Watt LED	1 x 50 W LED	1 x 50 W LED	2 x 50 W LED	2 x 50 W LED
Maximum Load in kg.	350	350	500	500	1000	1000
Filter Cartridge	1 x 4m ²	2 x 4m ²	2 x 4m ²	3 x 4m ²	2 x 21m ²	3 x 21m ²
Power Supply	230V/50Hz/0,85 kW	230V/50Hz/0,85 kW	415V/50Hz/1,2kW	415V/50Hz/1,6kW	415V/50Hz/3,3kW	
Air Consumption at 6 bar and 8mm nozzle	±800 - 1000 lt./ min	±800 - 1000 lt./ min	3000 liter/ min at 4 bar			

DP Pressure Blasting Cabinets

The DP Pressure Blasting cabinets are equipped with a cyclone, which guarantees that the abrasive is cleaned perfectly. This results into less wear and better visibility. The pressure pot is equipped with a dosage cylinder which always ensures the right mix of abrasive and pressurized air. Also, the dosage cylinder controls a constant flow of an abrasive, even at the start of the blast process. This results in an effective and efficient blast process.

Key Features

- Efficient powerful blasting.
- Blasting process free of interruption.
- Continuous clear view due to optimal circulation of air.
- Cabinet without foundations, compact construction.
- Efficient cleaning of abrasives by cyclone.
- Optimal blast media dosage with dosage valve.

Wet Blasting Cabinets

ActOn range of Wet Blasting Cabinets include and economical option (AWB-1100) & a premium series (NP12).

AWB-1100 Wet Blasting Cabinet

The AWB-1100 is a wet blasting cabinet ergonomically designed for easy operation in sitting or standing position, for cleaning, descaling, deburring, roughening, oil or grease removal, die cleaning. This machine is suitable for blasting with all kinds of inert abrasives.

Key Features

- Stable cabinet, sturdily constructed of mainly SS sheet with sectional reinforcements.
- 1 large stainless steel swing door with seals, gutter and safety switch arrangement.
- In cabinet-top integrated LED lighting unit for optimum vision in the blast-chamber
- Angled full view, hardened glass security window, provided with electric wiper motor and wiper arm / wiper blade.
- Replaceable operator protective abrasive resistant full length rubber gloves.
- Glandless vertical polypropylene slurry pump with 3000 rpm electric motor.
- Pressure regulator to control air flow.
- Electrically operated foot pedal .
- Internal blast chamber lined with plastic sheets for protection.



Click [here](#) to download our Shot Blasting brochure for further technical information



AWB-1100



NP Wet Blasting Cabinet

The NP Wet Blasting cabinets are equipped with a special pump that achieves a constant flow of blast media and water to the blast nozzle. The media and water is mixed with pressurized air to add extra power and speed to the mix. The result is a very smooth finished component. The water and abrasive are collected in a funnel, and the pump provides an agitation so that the abrasive continues to "float".

NP Wet Blasting cabinets are perfect for applications such as cleaning, descaling, deburring, roughening, oil or grease removal, die cleaning as dimensions are not affected, or to achieve a smoother surface in compliance with HACCP. These machines can be used with all kinds of inert abrasives.

Key Benefits

- Dust-free blast process.
- De-grease and blast in one process.
- Almost zero impression of the abrasive in the surface.

Technical Specifications

	NP 12	AWB-1100
Blast Chamber Dimensions in mm/inch (W x D x H)	1100 x 940 x 820 / 43.4 x 37 x 32.3	1100 x 1000 x 800 / 43.4 x 39.4 x 31.5
Overall Dimensions in mm/inch (W x D x H)	1250 x 1360 x 1850 / 49.2 x 53.5 x 72.8	1465 x 1700 x 1800 / 57.7 x 66.9 x 70.8
Door Opening in mm/inch (W x H)	830 x 720 / 32.6 x 28.3	860 x 710 / 33.8 x 27.9
Floor Working Height in mm/ inch	810 / 31.8	1080 / 42.5
Approx. Machine Weight in kg	450	370
Air Consumption	1.100-2.200 literst./min (8 mm nozzle), depending on adjustment of water pump and air injector.	1.100-2.200 lt./min (8 mm nozzle), depending on adjustment of water pump and air injector.



NP12



Wet Blasting Automated System

We designed this Automated Wet Blast machine for blasting of shafts prior to coating. The system consists of two blasting lines which can blast up to 70mm Ø shafts. Parts travel through the blast chamber and then enter the water wash chamber to remove any residue that may be on the components. The parts are then air dried before exiting.

Key Benefits

- Consistent finish across all parts.
- Fully automated system.
- Fast throughput rate.
- Programmable recipes.
- Adjustable settings including conveyor & pump speeds.
- British built high-quality vibratory bowls.
- Efficient in operation.



Air dry chamber



Slurry tank and pumps

before



after

Other Automated Blasting Cabinets

Automated blasting cabinets reduce manual handling and ensure a consistent process. Our automated systems are operator friendly, and can be custom built to suit your needs. Whether you require to deburr, descale, remove corrosion, mill scale, paint or rust, achieve a smooth finish, deflash, polish, shot peening or remove powder from components of different sizes we will offer you full support every step of the way.

Satellite Blasting Cabinets

The Satellite Blasting Cabinets have been built to allow you to process complex parts. One of the main advantages of this system is the fact that components do not come into contact, hence any possible part damage is avoided.

These cabinets are perfect for applications such as die cleaning, removing rolling skin from forged parts, fine blasting, and polishing.



Key Features

- Available in various specifications.
- Integrated table with multiple satellites in one system, hence parts are changed within the unit.
- Includes mobile table with satellites, making it possible for parts to be exchanged outside the unit.
- Continuous exchange of parts during the process.

Drum Blasting Cabinets

The Drum Blasting Cabinets have been built to allow you to process small parts. These machines are widely used in the 3D Printing industry. When blasting Aluminium, Titanium, PA or PP parts, an explosion-proof execution is necessary. This can consist of a cell wheel lock, rupture disk, non-return valve, flow control, Ex. motor and fan.



Turntable Blasting Cabinets

The Turntable Blasting cabinets are suitable for blasting bigger / heavier, often round components. Products are placed on a turntable and are blasted by the rotation of the table in combination with the oscillating nozzle movement. The turntable can be placed permanently in the cabinet. Or brought outside the cabinet with a transport system, so that loading using a crane/forklift is possible. Finishing applications include deburring, cleaning, shot peening and roughening.



Transit Blasting Cabinets

The Transit Blasting Cabinets have been designed to achieve a matt, deburred or rough finish. After parts are placed in the machine, the doors close. Components are then blasted by an oscillating movement of the nozzles (from front to back) and a stroke movement in the horizontal plane of the parts. The blasting can be carried out on top, bottom or both sides. Can be easily integrated with other production machines and it can blast as a batch system or a continuous system.

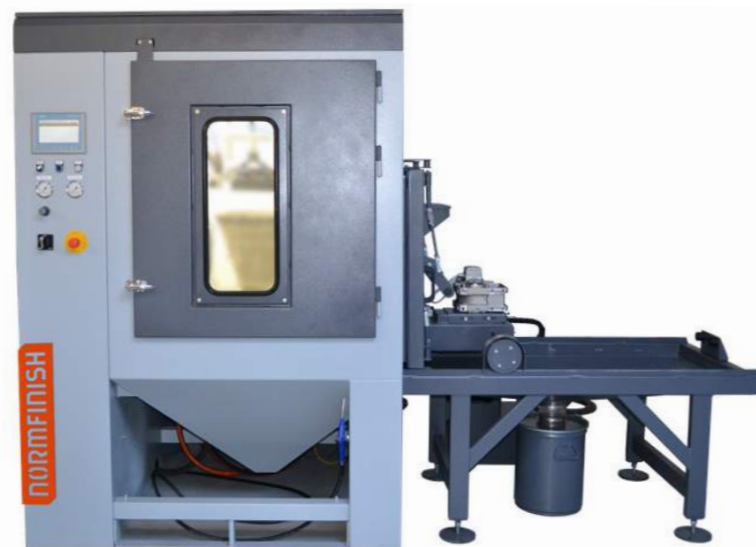

Internal Blasting Cabinets

The Internal Blasting Cabinets are suitable for the internal clean blasting of hollow components, such as gas cylinders, fire extinguishers, diving tanks, etc. After parts are placed inside the system, these are rotated and the nozzle makes an upward and downward movement, thus finishing the components.



Shot Peen Blast Installations

The blasting medium is sieved and it is optional possible to control the roundness. The dosage of the blasting medium can optionally be controlled. This can be carried out in all the above-mentioned blast cabinets.



Rollers and Tubes Blasting Cabinets

The Turntable Blasting cabinets are suitable for simultaneous blasting of pipes or other long round components. Finishing applications include cleaning, shot peening and roughening.

Key Features

- Different designs can be developed
- Parts rotate and are transported through the installation during the blast process.
- Adjustable speed.





Wheel Blasting Systems

Manufacturing industries are rapidly evolving towards more efficient finishing processes, in order to achieve a repeatable and high-quality finished product. At ActOn Finishing we offer a wide range of wheel blasting solutions that improve current processes, catering to applications such as descaling, removal of corrosion or rust, paint stripping, de-flashing, achieving a smooth finish, shot peening, polishing and surface preparation prior to coating.







Click [here](#) to download our Wheel Blasting brochure for further technical information.



PG Series Spinner Hanger Blast Machine

Designed to shot blast components of all sizes, complex shapes and fragile parts. ActOn PG Series are built with hooks or hoists for heavier parts. Moreover the Spinner Hanger Blasting Machines can process large components which cannot be tumbled together during the shot blasting process, due to the risk of impingement.

Finishing Applications

-  Paint stripping
-  Descaling
-  De-sanding castings
-  Deburring & cleaning aluminium pressure diecastings
-  Shot peening
-  Removal of rust
-  Blast cleaning



TG Series Tumble Rubber Belt Shot Blasting Machine

The TG Tumble Rubber Belt Blast Machine is ideal to shot blast batches of small or medium parts and fragile components. Any type of material can be processed in these machines, from forged and heat-treated components, to steel, aluminium and brass parts and fragile plastic components.

Finishing Applications

-  Surface treatment
-  Descaling
-  Cleaning
-  Deburring
-  De-sanding
-  Corrosion removal
-  Paint stripping
-  Heat scale removal



TA Series Tumble Steel Belt Shot Blasting Machine

Ideal to shot blast batches of medium to large and heavy parts. For de-sanding applications, this machine can be offered with magnetic drums. The TA series is recommended for finishing steel & brass press-forged parts, cast iron, aluminium, steel or brass castings & heat-treated components. One of the advantages of this machine is that it can process part's internal cavities, leaving them perfectly clean.

Finishing Applications

- Surface treatment
- Descaling
- Cleaning
- Deburring
- De-sanding
- Corrosion removal
- Heat scale removal



STL/A Series Wire Mesh Belt Shot Blasting Machine

STL/A Wire Mesh Belt Shot Blasting Machines are built for a continuous shot blasting process of aluminum and steel parts. These machines are also perfect for processing components slots and wholes which are difficult to reach, such as gears, die-castings, castings, gearboxes or forged parts.

Finishing Applications

- Surface preparation
- Descaling
- Deburring
- Rust removal
- Heat scale removal
- Satin finish
- Shot peening



GSA Series Continuous Feed Overhead Rail Blasting Machine

These machines are built for treatment of components hanged on a hook which run on a O-ring motorised overhead rail. The displacement of hangers is automatic with a step by step system to ensure a constant productivity. This shot blasting equipment is widely used by steel, cast iron and aluminium foundries for the surface cleaning of metallic products.

Finishing Applications

We recommend this system for applications such as: descaling, deburring, surface preparation, shot peening, removal of moulding sand, improve surface roughness.



Horizontal Series Roller Conveyor Blast Machine

The Roller Conveyor Shot blasting machines are designed to process metal sheets or plates, profiles and metallic structures and any other long or/ and flat component, in a continuous feed process. The Horizontal blast machines can be provided with a painting tunnel for the automatic application of protective primer.

Finishing Applications

- Descaling
- Cleaning
- Surface preparation to ensure the adhesion of protective paint.
- Paint stripping
- Removal of rust
- Removal of corrosion & heat scale



RT Series Rotary Table Blast Machine

The Rotary Table Shot Blasting Machine is suitable for shot blasting small and medium size parts. This installation is provided with a variable speed drive controlled turbine and a turntable, which has a diameter of 2500 mm. The Rotary Table blast machine is built to be compact, with minimum space being required.

Finishing Applications

- Paint stripping,
- Corrosion, rust and heat scale removal,
- Deburring,
- De-flashing,
- Cleaning
- Surface texturing.



STL Series Tunnel Concrete Shot Blast Machine

A Shot Blast machine designed for surface treatment of marble, granite, natural stone, concrete and aggregate blocks to obtain a bush-hammered, flame treated, antique appearance finishing. STL offers a high productivity with very low operating costs, when compared to commonly used traditional systems. It is also possible to simultaneously treat the top and side surfaces of the component.

Finishing Applications

We recommend the STL shot blasting machine for surface treatment of streetscape, flooring, coatings, columns, artistic elements, funeral components, indoor flooring and kitchen worktops.



GRT Series Continuous Feed Tube & Bar Blast Machines

A continuous feed shot blasting machine perfect for finishing pipes, bottles, cylindrical parts, round bars, torsion bars, gas cylinders and drill rods. This system can be easily integrated into existing production lines. The GRT Series includes 2 models which have been designed for: Model GRB/ 4TR - for processing 200 bottles/ hour; Model GRT 180 /6TR - for blasting steel blooms weighing 65 tons max and of 1,80 m max in diameter.

Finishing Applications

- Deburring
- Cleaning
- Surface preparation and texturing
- Paint stripping
- Removal of rust, corrosion & heat scale
- De-flashing
- Shot peening



Consumables

Over the years, we have been at the forefront of the industry, developing a range of consumables with the aim of achieving the desired finish on various components.

By working closely with highly skilled manufacturers, our Engineers understand the numerous challenges faced in different industries, which has led to the development of suitable consumables.

Choosing the right consumables is crucial in achieving your desired finish, and we endeavour to help you, and all customers, select the media and compounds right for your products.

Click [here](#) to download our Consumables brochure for further technical information and media dimensions.



Ceramic Media

Our ceramic media comes in a variety of abrasive grades, starting from low abrasive to super finishing. This type of media is suitable for various deburring, radiusing and polishing processes, and is specially formulated to go hand-in-hand with ActOn's compounds. We offer ceramic media in the following shapes and grades:

Media Grade	Grinding Performance	Triangle		Cylinder		W Wedge	S Star	TR Tristar	ACTR Angle Cut Tristar	E Ellipse	ACE Angle Cut Ellipse	AR Arrow	P Pyramid	C Cone	R Rhombus	B Ball
		ACT Angle Cut	SCT Straight Cut	ACC Angle Cut	SCC Straight Cut											
P		○	○	○	○	○		○	○	○	○	○				○
RP1		○	○	○	○		○	○	○	○	○	○	○	○		○
ST1		○	○	○	○					○	○			○		
CFB		○	○	○	○					○						
CC1		○	○	○	○	○	○	○	○	○	○	○	○	○	○	○
CC4		○	○	○	○	○	○	○	○	○	○	○	○			○
CC8		○	○	○	○	○	○	○	○	○	○	○			○	
SFB		○	○	○	○	○	○	○	○	○	○	○			○	
SFC		○	○	○	○	○	○	○	○	○	○	○			○	



Plastic Media

Our range of plastic media comes in various grades, shapes and sizes and is specially designed for smoothing processes and removing light burrs. This media also reduces the risk of part damage, and gives a consistent, bright and matte finish. We offer plastic media in the following shapes and grades:

Media Grade	Grinding Performance	C Cones	Pa Paracones	P Pyramid	T Tetra	Tr Tristar	W Wedge	O Octocone	B Button	ACT Angle Cut Triangle
YL		○	○	○	○	○	○	○	○	○
P2F		○	○	○	○	○	○	○	○	○
PMD		○	○	○	○	○	○	○	○	○
BL		○	○	○	○	○	○	○	○	○
PIK		○	○	○	○	○	○	○	○	○
P3W		○	○	○	○	○	○	○	○	○
PSG		○	○	○	○	○	○	○	○	○
PDV		○	○	○	○	○	○	○	○	○
PSE		○	○	○	○	○	○	○	○	○
P7M		○	○	○	○	○	○	○	○	○
BR		○	○	○	○	○	○	○	○	○
P62		○	○	○	○	○	○	○	○	○
PSS		○	○	○	○	○	○	○	○	○
PTX		○	○	○	○	○	○	○	○	○



Agro Media

Part of our agro media range are the corncob & walnut shell. Both products come in various grain sizes, which are carefully chosen to suit the specific parts. The corncob grains are known to have high abrasion resistance, good moisture absorption, low specific gravity & are used mainly for drying in the Rotary Dryers and Vibratory Dryers. Walnut shell is a hard and fibrous material of medium abrasiveness, and is used in both the polishing and deburring processes as it leaves no scratches or pitting.

We offer:

- Corncob with a grain size of 4, 6, 8, 10, 12, 16, 20, 30, 80 & 200
- Walnut shell with a grain size of 1/12, 2/12, 3/16, 4/20 & 5/30



Pre-treated Media

ActOn offers pre-treated corncob and walnut shell. The pre-treated corncob has been developed to produce a bright mirror finish. This can be used both in vibratory and high energy machines. The pre-treated walnut shell imparts high lustre on components. It has been proven that on certain materials, pretreated walnut produces a much brighter finish than pre-treated corncob.

We offer:

- Pre-treated corncob with a grain size of 4, 6, 8, 10, 12, 16, 20, 30, 80 & 200
- Pre-treated walnut shell with a grain size of 1/12, 2/12, 3/16, 4/20 & 5/30

All of our agro media and pre-treated media comes in a treated, bovine-free form.

Special Plastic Media

ActOn special plastic media has been developed to finish parts manufactured out of non-ferrous materials, semi-precious and precious alloy and also stainless steel. Some of the applications include grinding and polishing. ActOn offers different types of special plastic media:

- SPM4 (particularly good for achieving a low surface finish on medical implants manufactured using materials such as Cobalt Chrome and Stainless Steel).
- SPM7, SPM6 and SPM5 (recommended for removing machining lines on Cobalt Chrome and Stainless Steel parts, SPM7 being the most aggressive plastic media option).



Stainless Steel Media

Our special media range includes:

Stainless Steel media mainly used for burnishing, cleaning and light deburring. This media wears very slowly with a life of up to 10,000 hours. We offer SS Balls, SS Ball Cones and SS Pins

Special plastic media developed to finish components manufactured out of non-ferrous materials, semi-precious and precious alloy and also stainless steel. Some of the applications include grinding and polishing.

Wood media great for smoothing, polishing, light deburring and drying. This media is offered in shapes such as Cubes, Diamonds and Pegs.



Wood Media

Wood media is generally used in dry finishing processes, in vibratory finishing machines and centrifugal finishing machines. Used in combination with finishing compounds, this media is great for applications such as, smooth finishing, polishing, dry tumbling or light deburring. Wood media comes in shapes such as cubes, diamonds and pegs can be used on parts manufactured from materials such as plastic, nylon, ceramics, wood and metals.



Shot Blasting Media

ActOn offers a wide range of Abrasive Consumables for shot blasting and peening processes including: **Aluminium Oxide, Glass Beads, Metallic Blasting Media (such as Steel Shot, Steel Grit, Chilled Iron Grit, Cut Wire Shot), Plastic Blast media, Silicon Carbides, Walnut Shell, Brown, Pink and white Alumina and Ceramic Beads.**

Using ActOn abrasive consumables you can achieve the desired Sa standards to ensure that the part's surface is cleaned to the required specification



Click [here](#) to download our Consumables brochure for further technical information and media dimensions.

Liquid Compounds

ActOn liquid compounds are specially formulated for vibratory and high energy finishing machines. They comprise of abrasives, brighteners, lubricating agents, cushioning materials & cleaning agents. Our compounds are environmentally friendly and biodegradable that suit our customers' requirements.

Compound Name	Description	PH	Application guide
LQ18	Light descaling, removal of rust & discolouration due to heat treatment processes. Removes metal oxides to produce a bright polish, retaining base metal colour	1 - 2	Excellent for: brightening & polishing Good for: ball burnishing, pickling Average for: foaming
LQ18M	Acidic compound for removal of light heat treatment, scale, brightening & polishing suitable for ferrous and non-ferrous metals. Widely used in the aerospace sector.	2.5 - 3	Excellent for: pickling, descaling, de-rusting, remove light heat treatment Good for: brightening & polishing, ball burnishing
LQ9	Specially formulated for polishing and brightening of ferrous & non-ferrous metals.	< 4	Excellent for: brightening & polishing, pickling, foaming Good for: ball burnishing
LQ60	A low-cost, multipurpose compound for all metals. Grinding, deburring, polishing on all metals. Used for obtaining bright color. Can be used with all types of media and for self tumbling operations.	10 - 11	Good for: brightening & polishing, cleaning, corrosion inhibition Average for: ball burnishing, foaming
LQ14	General cleaner with good polishing properties for all metals.	8 - 8.5	Good for: brightening & polishing, cleaning, Average for: ball burnishing, corrosion inhibition, foaming
LQ15D	Specially formulated for die-cast products. Excellent cleaning & emulsifying properties.	8 - 8.5	Excellent for: cleaning Good for: brightening & polishing, ball burnishing, degreasing, de-oiling Average for: foaming
LQ17	Multi-purpose liquid for cleaning ferrous metals. Contains strong corrosion inhibitor. Mainly use on ferrous metal.	8 - 8.5	Excellent for: cleaning Good for: brightening & polishing, ball burnishing, corrosion inhibition Average for: foaming
LQ19	Multi-purpose compound for all metals.	8 - 8.5	Good for: ball burnishing, cleaning, corrosion inhibition Average for: brightening & polishing, foaming
LQ30	Concentrated compound for all metals. Good cleaner & polisher with corrosion inhibitor.	8 - 8.5	Excellent for: brightening & polishing, ball burnishing Good for: cleaning, corrosion inhibition, foaming
LQ16	Concentrated cleaner and polisher for non-ferrous metals.	8.5 - 9	Excellent for: brightening & polishing, ball burnishing Good for: cleaning Average for: foaming
LQ11	Powerful degreaser and cleaner with good inhibitor qualities designed for ferrous metals.	10 - 11	Excellent for: cleaning, degreasing, de-oiling Good for: corrosion inhibition Average for: foaming
LQ111	Powerful degreaser & cleaner suitable for heavy machining oils & lubricants. Designed for ferrous metals. Saponify & emulsify oils, greases. Inhibits corrosion. Low foaming properties.	10 - 11	Excellent for: cleaning, degreasing, de-oiling Good for: corrosion inhibition Average for: foaming
LQ11S	Cleaning, degreasing of ferrous metals. Saponify & emulsify oils and greases. Used in various industrial washing & spraying machines for degreasing & cleaning.	10 - 11	Excellent for: cleaning, degreasing, de-oiling, corrosion inhibition Average for: foaming

Powder Compounds

As well as a comprehensive range of liquid compounds, ActOn Finishing offers a full range of Powders & Pastes. These are used for grinding, cleaning and polishing of ferrous and non-ferrous materials for vibratory and high energy finishing machines.

	Compound Name	Description	PH	Application guide
Abrasive Compounds	A0	An aggressive, coarse, concentrated, abrasive compound, used on harder metals for grinding, radiusing and the removal of heavy machine marks and burrs. Used with an abrasive media, it leaves the surface of parts with a shot-blast appearance	9 - 10	Excellent for: cleaning, descaling, de-rusting, remove light heat treatment Good for: corrosion inhibition Average for: brightening & polishing, foaming
	A1	A fast-cutting compound for heavy deburring and, combined with cleaning agents, it is mainly used for ferrous components, brass cuttings and pressings. Leaves the surface with a matte finish.	11 - 12	Excellent for: cleaning, descaling, de-rusting, remove light heat treatment Good for: corrosion inhibition Average for: brightening & polishing, foaming
	A2	A medium, abrasive compound that is combined with cleaning agents.	11 - 12	Excellent for: cleaning Good for: corrosion inhibition, descaling, de-rusting, remove light heat treatment Average for: brightening & polishing, foaming
	A3	A light deburring compound combined with cleaning agents for fine surface finishing of all materials, but mainly used on soft metals like zinc, brass or aluminium. It can also be used to bring back the surface on ceramic media which is contaminated.	10 - 11	Excellent for: cleaning Average for: brightening & polishing, descaling, de-rusting, remove light heat treatment, foaming
	A7	It is a light grinding compound for cutting down and polishing that contains an extremely fine abrasive, which during the process breaks down into a slurry. This assists the polishing ingredients to impart a polished surface	9 - 10	Good for: brightening & polishing Average for: cleaning, corrosion inhibition, foaming
	35F	This is used for the cutting and polishing of non-ferrous metals and contains a soft abrasive with polishing agents.	5 - 6	Good for: brightening & polishing Average for: foaming
Polishing Compounds	P6	It is used for polishing copper and its alloys with non abrasive media. A silky foam lather is built which enhances the polishing process.	9 - 10	Excellent for: brightening & polishing, ball burnishing, cleaning Good for: foaming
	P51	A polishing compound for aluminium with extra brightening and polishing agents giving superb results. Mainly used with steel media or plastic media to give a semi polished matte finish.	9 - 10	Excellent for: brightening & polishing, ball burnishing, cleaning Average for: foaming
	P71	It produces a clean, bright lustre and keeps the metal in solution allowing the process to continue for long periods. This is suitable for zinc and zinc alloys. Mainly used with non abrasive media.	9 - 10	Excellent for: brightening & polishing, cleaning Average for: descaling, de-rusting, remove light heat treatment, foaming
Cleaning and Degreasing Compounds	C1	Used to remove grease, oils and lubricating fluids leaving metal components clean and ready for further processes.	12 - 13	Excellent for: cleaning, degreasing, de-oiling Good for: brightening & polishing Average for: foaming
	C4	Used for cleaning of ferrous components and can be used with all types of media.	12 - 13	Excellent for: cleaning Good for: foaming
	C5	It keeps processes free of grease and oil. Good rust inhibitor. Mainly used on ferrous components.	12 - 13	Excellent for: cleaning, degreasing, de-oiling Good for: brightening & polishing, corrosion inhibition Average for: foaming
	C6	Cleaning compound with brightening and is used on ferrous components to give a clean bright surface finish. It contains a strong rust inhibitor. Abrasive and polishing media can be used with C6 compound.	11 - 12	Excellent for: cleaning, corrosion inhibition Good for: brightening & polishing Average for: foaming
	ActoClean BT (C7)	Used mainly on ferrous components to give a clean surface finish. It contains strong rust inhibitor	11 - 12	Excellent for: cleaning, corrosion inhibition, degreasing, de-oiling Average for: foaming
	C50	Suitable for processing all metals. Copes with all types of oily and greasy components. Contains corrosion inhibitor and can be used with all types of media.	10 - 11	Excellent for: cleaning, corrosion inhibition, degreasing, de-oiling Good for: descaling, de-rusting, remove light heat treatment Average for: foaming

Special Compounds

Compound Name	Description	PH	Application guide
Turbocut	A near neutral material to give a safe process for the rapid removal of metal on ferrous parts. Suited for steel & hardened steels in the hand tool industries. After the Turbocut process, the surface is ultra smooth and can be plated directly, eliminating expensive hand polishing.	6 - 7	Excellent for: removal of machining/ grinding lines Good for: cleaning, corrosion inhibition, descaling, de-rusting, remove light heat treatment Average for: foaming
Chemcut	Removal of grinding, lishing & machine marks. Recommended for steel, hardened steel & certain stainless steels only to give rapid metal cut-down and levelling, producing super smooth surfaces, ready for polishing and elector-plating if required. Mainly used with non-abrasive media.	1 - 2	Excellent for: removal of machining/ grinding lines Average for: foaming
Actogrind	This is an abrasive paste that is used in Vibratory Bowl machines for processing both ferrous and non-ferrous parts	6 - 7	Excellent for: removal of machining/ grinding lines Good for: brightening & polishing, descaling, de-rusting, remove light heat treatment Average for: foaming
Vibropol	This is a polishing paste and can be used on all metals.	8.5	Excellent for: brightening & polishing Good for: cleaning Average for: foaming
AD1	Used for descaling and rust removal of oxides, heat treatment, discoloration, welding scale, some carbon deposits, hard-water scale. Not used on zinc or magnesium.	< 1.5	Excellent for: descaling, de-rusting, remove light heat treatment Average for: foaming
Vibroshine	For use in vibratory beds with crushed walnut shell media for bright polishing of small ferrous and non-ferrous items.	6 - 7	Excellent for: brightening & polishing, degreasing, de-oiling Average for: foaming
Actopol 108	It is a fine long lasting clean cutting abrasive for normal burr & surface finish improvement. It prevents corrosion on ferrous parts & produces a clean smooth finish on all metal parts. This is used with ceramic, natural or soft metallic media.	9.3	Excellent for: removal of machining/ grinding lines, cleaning, corrosion inhibition Average for: foaming
Actopol 106	This is an abrasive compound for normal deburring and stock removal. It can be used with ceramic, natural or soft metallic medias, and is excellent for part-on-part processing. This produces a clean smooth finish on all metal parts.	9.0	Excellent for: removal of machining/ grinding lines, cleaning, corrosion inhibition Average for: foaming

Water Treatment Consumables

ActOn's effective water treatment system is a combination of equipment technology (ActOn Centrifuge System) and water cleaning products (flocclants and coagulants).

The ActOn Centrifuge system is connected to the mass finishing equipment. The effluent discharged from the finishing equipment is collected in a tank, where a strainer stops the heavy particles. The dirty water is pumped into the Centrifuge chamber which rotates at high speed to separate the impurities from the water. For special purpose, the flocclants can be added in the water tank for better coagulation and precipitation of the contaminants in the sludge basket provided in the Centrifuge. The coagulants and flocclants are used to separate the suspended solids from water.



ActOn Coagulants

Coagulants are added into the solution to neutralise the negative charges on non-settable solids. The coagulants have an opposite charge to the suspended solids.

Once the charge is neutralised, the small suspended particles are capable of sticking together. These slightly larger particles are called pin flocs. Water surrounding the newly formed pin flocs should be clear. If not, coagulation and some of the particle's charge have not been neutralised. More coagulant chemicals may need to be added.

Over-mixing of the coagulant with the suspended solids in the water does not affect coagulation, but insufficient mixing will leave this step incomplete.

Product Name	AC PAC	Ferric Sulphate	AC CL520
Liquid / Powder	Liquid	Liquid	Liquid
Anionic / Cationic	Cationic	Cationic	Cationic
Application	Coagulation of Metal Finishing Effluents – Product Choice Dependent on Chemical Nature of Effluent and Particle Size of Solids		
pH	1.8-2.5	0.5-1	5.5-6.5
Recommended Dosage	200-500ppm	200-500ppm	20-50ppm

ActOn Flocculants

Flocculation is the formation of larger flocs using high molecular weight polymers. These products help to bridge, bind and strengthen the pin flocs formed, adding weight and increasing settling rate. Once the floc has reached its optimum size and strength, the water is ready for sedimentation.

It is important not to over-mix the flocculent with the water as once the flocs formed are torn apart, it is not possible to get them to reform without the addition of more flocculent.

Product Name	AF AD985	AF AD987	AF AE66	AF 209	AF 990	AF A260	AF A320	AF K540	AF K560	AF K580	AF CE662	AF 528	AF CE682
Liquid / Powder	Dewatered Liquid Emulsion	Dewatered Liquid Emulsion	Liquid Emulsion	Powder	Powder	Powder	Powder	Powder	Powder	Powder	Liquid Emulsion	Powder	Liquid Emulsion
Anionic / Cationic	Low Anionic	Mid Anionic	Mid Anionic	Very Low Anionic	Low Anionic	Low/Mid Anionic	Mid Anionic	Mid Cationic	Mid/High Cationic	High Cationic	Mid/High Cationic	Anionic	High Cationic
Application	Flocculation of Metal Finishing Effluents – Product Choice Dependent on Chemical Nature of Effluent												
pH	3.5-4.5	3.5-4.5	6-8	6-8 (1%Soln)	6-8 (1%Soln)	6-8 (1%Soln)	6-8 (1%Soln)				4-6 (1%Soln)	6-8	4-6 (1%Soln)
Recommended Dosage	4-8ppm	4-8ppm	5-10ppm	3-5ppm	3-5ppm	3-5ppm	3-5ppm	5-10ppm	5-10ppm	5-10ppm	8-12ppm	5-10ppm	8-12ppm



Subcontract Services

On top of our state-of-the-art machinery and media, we also supply a range of support and training services. Moreover, we'll tailor our services and products to your needs, not the other way around. Our finishing service is all about you.

We suit our Finishing Technology and Subcontract Services to cover your needs. From a proved surface finishing technology we will adapt it according to your requirement.



Just [contact us](#). We will do the rest.



CHEF, CLM, CDF, Shot Blasting & Vibratory Finishing Subcontract



Precision Polishing and Inspection Services



Installation, Training, Maintenance Services



Equipment Refurbishment & Spare Parts Service

What Our Customer Say?

“ I have used Acton Finishing many times over the years and have always found them very helpful and knowledgeable about vibro finishing. The team will always come over and help and diagnose issues we have with our machines also. Highly recommended. ”

Luke Parker, Bracebridge Engineering Ltd.

“Recently purchased a VB20S for use in our manufacturing for motorsport division. Good value, great machine and attitude. professional sales, engineering and support pre and post installation, very much recommend.”

Eddie Beeston, Lohen UK

“We worked together to devise a series of tests and these were conducted by ActOn Finishing using a range of technologies employing different media types and a range of run times, to establish the optimised equipment and process to support our application. This was done quickly and professionally with regular updates along the way.

ActOn Finishing’s openness and willingness to conduct trials to establish the most suitable technology and process, was exactly what Ricoh required from a technical partner. As engineers, we like to capture lots of data to prove processes and learn through experimentation. During this collaborative project, we were able to share knowledge with ActOn Finishing to quickly establish a smoothing process for SLS printed parts. This open style learning approach is really important to Ricoh, because the knowledge developed provides value on both sides, which in turn increases the chances of future collaborative projects.”

Richard Minifie, Ricoh UK Product Limited



Quality You Can See

We pride ourselves on our excellence, and over the years we have successfully demonstrated an ongoing compliance with ISO quality and environmental standards. We’re also an approved supplier for many of our industries, including medical and aerospace.

For ISO, we currently hold:



“ The bitterness of poor quality remains long after the sweetness of low price is forgotten. ”

Benjamin Franklin



ActOn[®]

FINISHING

**Don't just think about it.
It's now time to ActOn it.**

ActOn Finishing Limited

213 Torrington Avenue, Tile Hill, Coventry, CV4 9HN, United Kingdom

+44 (0) 24 7646 6914

enquiries@acton-finishing.co.uk | www.acton-finishing.co.uk

ACT-36-EXH
Issue 14